

# Business Intelligence & Predictive Modeling (BIPM) Unified Student/Course Data System

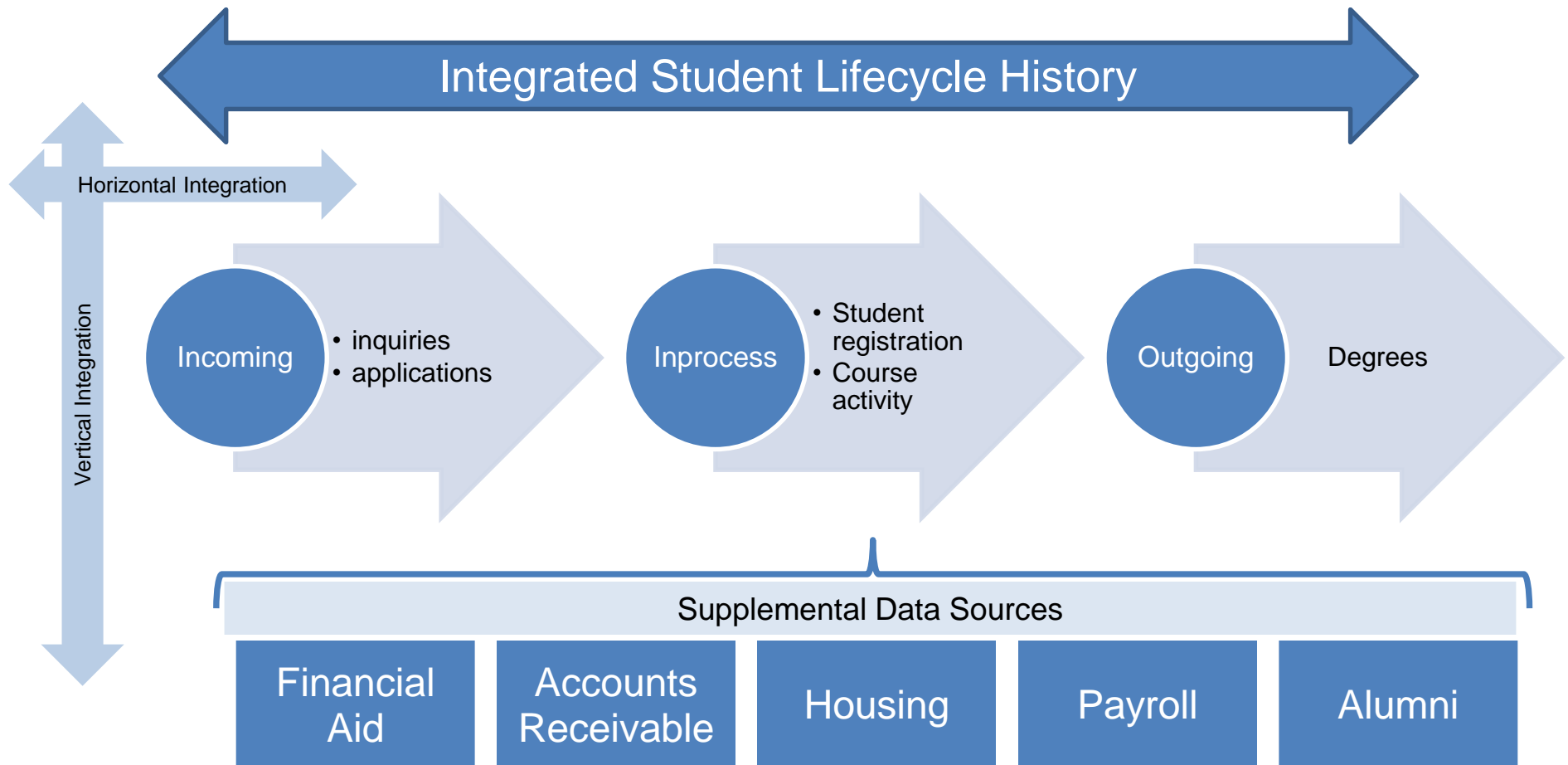

# BIPMS Student Core\* Tables

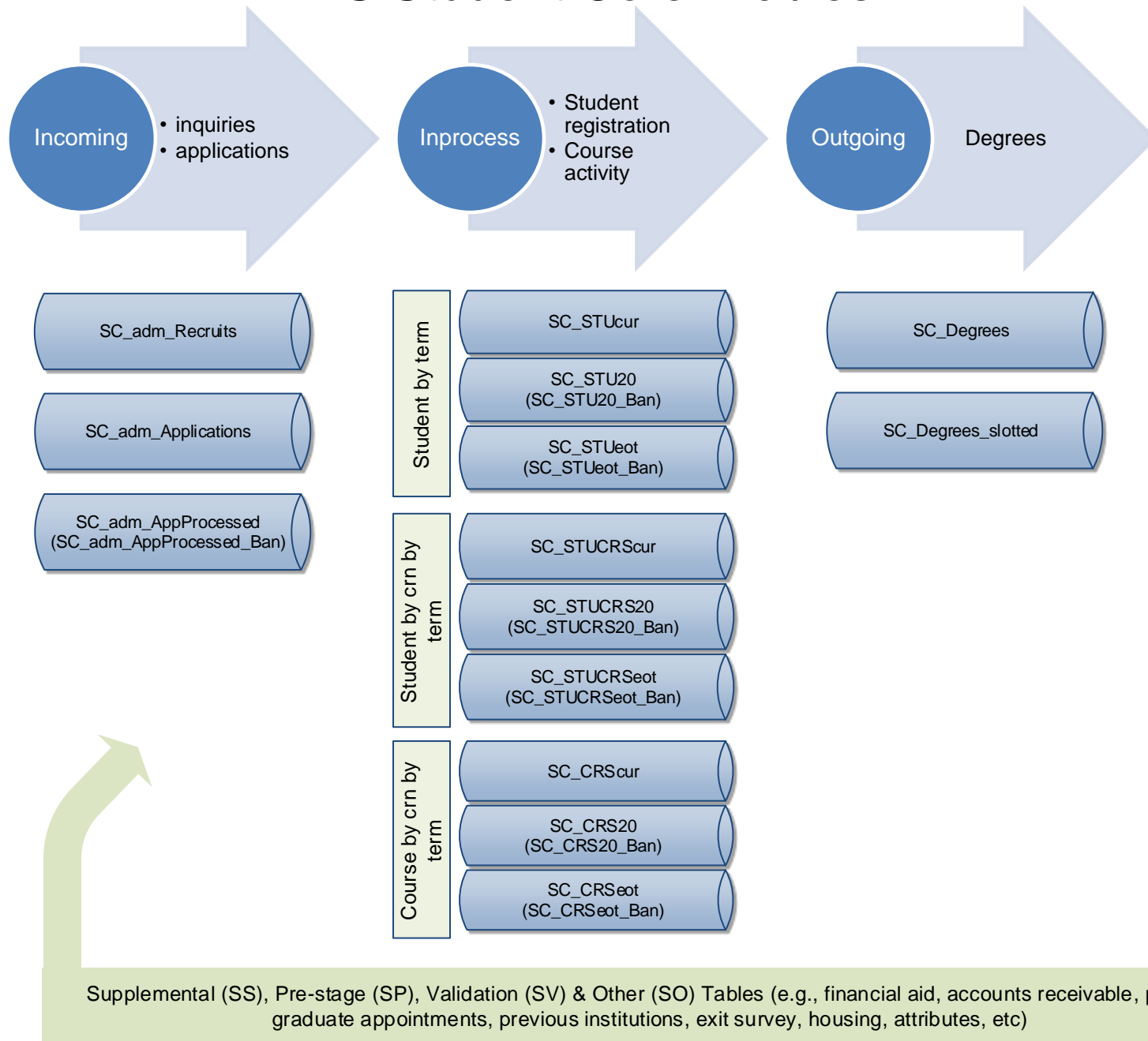

\* Core files (SC) contain base Banner data, managed data columns and may include legacy data  
Business Intelligence and Predictive Modeling (BIPM)

# Business Intelligence and Predictive Modeling (BIPM) SPSS Data-to-Information Processing

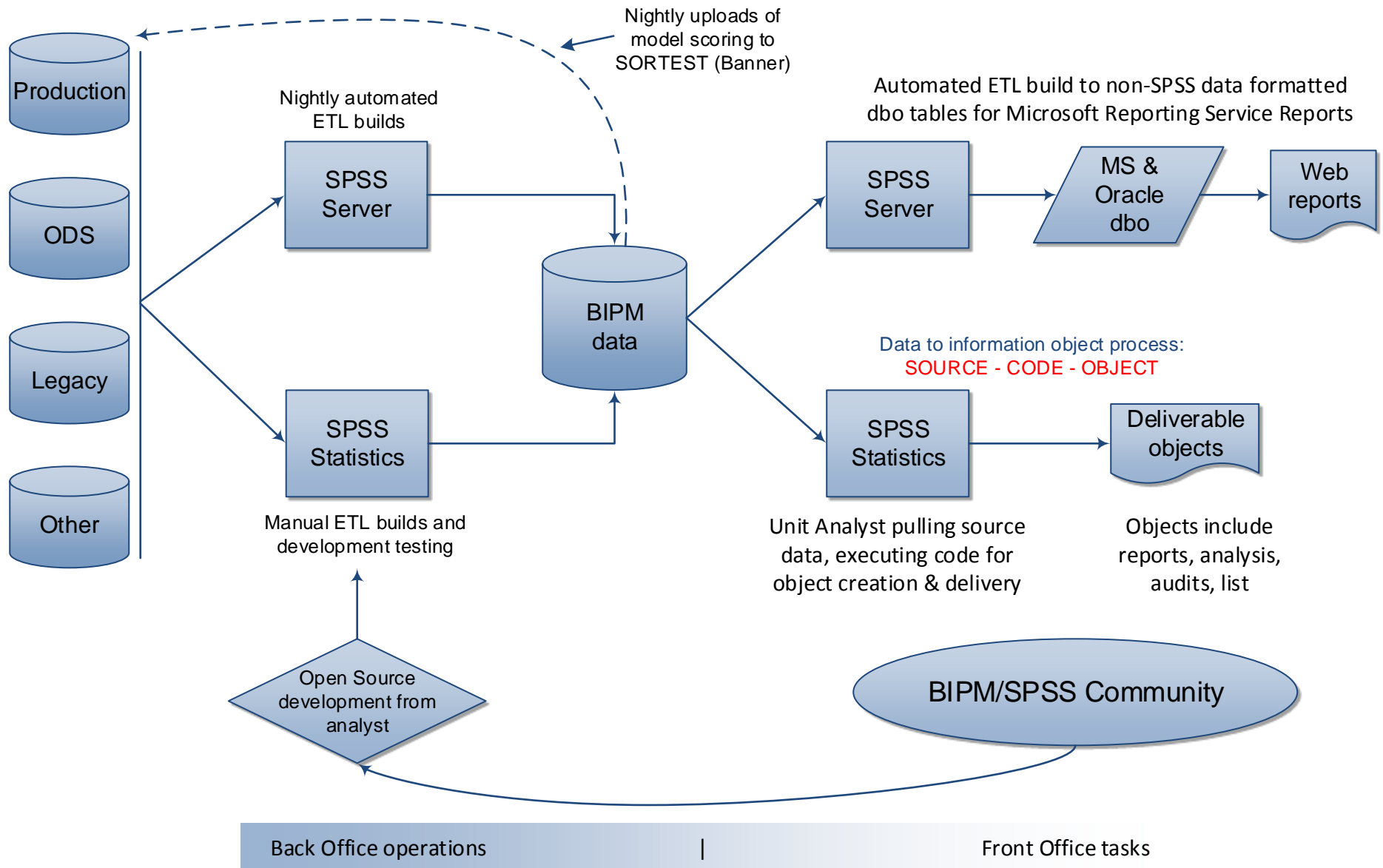

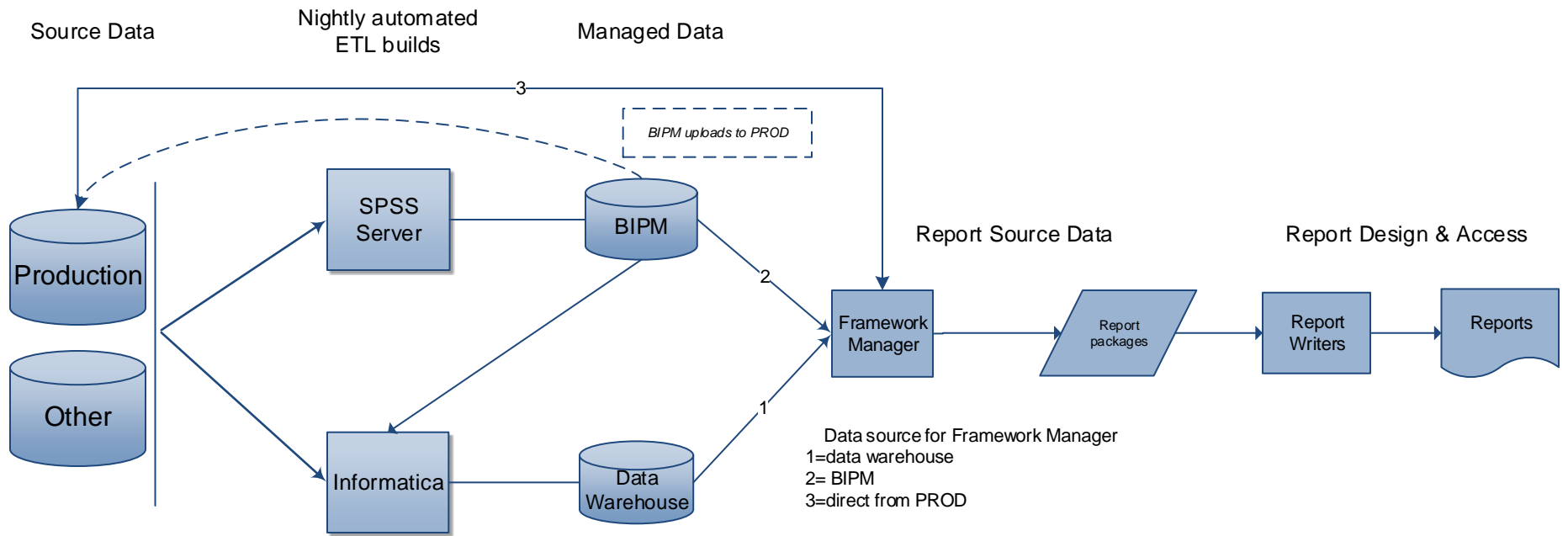

## Business Intelligence and Predictive Modeling (BIPM) File Types

### Student Core Files (SC):

{Core builds for reporting and analysis providing data at different student/course lifecycles}

\*SC\_adm\_Recruits [srbrecr recruit related] (2:25am)  
 \*SC\_adm\_Applications [saradap application related] (2:00am)  
 SC\_adm\_AppProcessed [legacy & banner processed apps] (3:30am)

SC\_STUcur [student current term] (4:50am)  
 SC\_STU20 [student 20thday]  
 SC\_STUeot [student end-of-term]

SC\_STUCRScur [student at crn level current term] (4:50am)  
 SC\_STUCRS20 [student at crn level 20<sup>th</sup> day]  
 SC\_STUCRSeot [student at crn level end-of-term]

SC\_CRScur [course at crn level current term] (4:50am)  
 SC\_CR20 [course at crn level 20<sup>th</sup> day]  
 SC\_CRSeot [course at crn level end-of-term]

SC\_Degrees [student degrees repeating table] (3:25am Sun)  
 SC\_Degrees\_slotted [student deg non-repeating table] (3:25amSun)

### Student Reporting Files (SR):

{data used to feed scheduled reports or Reporting Services}

SR\_adm\_AppFreeze\_Fall [weekly Fall app freezes] (M 4:30am)  
 SR\_adm\_AppFreeze\_Spring [weekly Spring app freezes] (M 4:30am)  
 SR\_adm\_AppFreeze\_Summer [wkly Summer app freezes] (M 4:30am)

\*SR\_adm\_Applications\_Errors [daily application errors] (2:20am)  
 \*SR\_adm\_Recruits\_errors [daily recruit errors] (3:25am)

\*SR\_AtRisk\_CRS [high DF grade courses]  
 \*SR\_AtRisk\_STU [student at risk report] (3:50am)

\*SR\_GradAppts\_appt\_viol\_rpt [appt level GA violations] (3:00am)  
 \*SR\_GradAppts\_stu\_viol\_rpt [student level GA violations] (3:00am)  
 \*SR\_GradAppts\_MissnRecsAudit [nbrjobs pwract match]

\*SR\_SESF\_Audits [spoken english screening form audit]

(reports below are ran daily during pre-registration thru 20<sup>th</sup> day)  
 SR\_REGSTUpre20\_Fall [pre20thday Fall daily registration] (4:00am)  
 SR\_REGSTUpre20\_Spring [pre20thday Spring daily reg] (4:00am)  
 SR\_REGSTUpre20\_Summer [pre20thday Summer daily reg] (4:00am)  
 SR\_REGSTUpre20\_Lastreg [pre20thday last reg activity] (4:00am)  
 \*SR\_BIS210IE\_pre20th\_Reg [pre 20th reg foreign only] (4:00am)

### Student Supplemental Files (SS):

{Supplemental data used to feed CORE tables}

SS\_adm\_MFR [MFR school & area rankings]  
 SS\_adm\_PreCollegeCurr [pre college curriculum] (3:00am)  
 SS\_adm\_UGnewStuORT\_all [summer orientation] (3:00am)  
 SS\_adm\_UGnewStuORT\_last [summer orientation] (3:00am)  
 SS\_AFD\_AlumniSurvey [AFD post graduation survey]  
 SS\_AFD\_ExitSurvey [UG & GR exit surveys] (3:00am)  
 SS\_enrlhist [enrollment history of student] (3:00am)  
 SS\_enrlhist\_1stTerm [1<sup>st</sup> term student enrolled] (3:00am)  
 SS\_Faculty\_GradFaculty\_Status [Graduate faculty status]  
 SS\_Faculty\_Sabbatical\_History [Sabbaticals]  
 SS\_Faculty\_Staff\_Nov\_Employ [employed personnel fte/counts]  
 SS\_Faculty\_Teaching\_History [teaching history by crn]  
 SS\_Faculty\_TenureRank\_History [Tenure & rank by term]  
 SS\_Faculty\_TenureRank\_Latest [latest tenure rank & other]  
 SS\_FinAid [financial aid] (3:00am)  
 SS\_GradAppts [graduate appointments] (3:00am)  
 SS\_Housing [housing] (3:00am)  
 SS\_Housing\_Applications [applications by term]  
 SS\_Housing\_Occupants [detail occupants data]  
 SS\_KBOR\_UGadvSurvey {student advising survey}  
 SS\_Payroll [payroll] (3:00am)  
 SS\_prevINST [previous institution history] (3:00am)  
 SS\_raceh\_inb [race ethnicity] (3:00am)  
 SS\_SARD [student accounts receivable database] (3:00am)  
 SS\_SGRSATT[student learner attributes] (3:00am)  
 SS\_STU20\_Cohorts  
 SS\_STUeot\_Demo  
 SS\_STUhist\_demo [student demographics] (3:00am)

### Student Validation Files (SV):

{Validation tables for non-repeating codes or term related data}

\*SV\_AAdiv\_orgs [Banner org codes] (3:00am)  
 \*SV\_adm\_Apps\_Freeze\_weeknum [week num counting system]  
 \*SV\_CCG\_Course [subject code CCG course codes]  
 SV\_CIP\_codes [CIP codes for majors & courses]  
 SV\_Kansas\_county\_zipcodes [KS zipcodes within counties]]  
 SV\_leg\_inb\_col\_code\_crswlk [leg inb crosswalk]  
 SV\_leg\_inb\_hs\_code\_crswlk [leb inb crosswalk]  
 SV\_leg\_pvid\_pidm\_ID [legacy pvid pidm crosswalk]  
 \*SV\_MCG\_Majors [MCG major code]  
 SV\_payroll\_semester\_breaks [payroll semester breaks]  
 SV\_Poverty\_Thresholds [poverty level thresholds]  
 \*SV\_SARD [student accounts receivable database codes] (3:00am)  
 \*SV\_term\_codes [term codes]

### Student Pre-Stage Files (SP):

{data used to build CORE tables during ETL execution}

SP\_adm\_AppFreeze [weekly refresh app freeze] (M 3:20am)  
 SP\_adm\_AppProcessed\_inb [banner apps] (3:30am)  
 SP\_adm\_AppProcessed\_leg [legacy apps]  
 SP\_Degrees\_POS\_detail\_inb [pln of stdy history] (N 3:25am)  
 SP\_Degrees\_POS [plan of study data] (N 3:25am)  
 SP\_enrlhist\_stueot [end of term student enroll hist]  
 SP\_Faculty\_Teaching\_History\_Legacy [teach hist legacy]  
 SP\_FinAid\_leg [legacy financial aid]  
 SP\_Payroll\_inb\_detail [banner payroll detail] (3:00am)  
 SP\_Payroll\_leg [legacy payroll]  
 SP\_Payroll\_leg\_detail [legacy payroll detail]  
 SP\_REGSTUpre20\_archive [refresh & archive reg]  
 SP\_STU20\_inb [banner student 20thday]  
 SP\_STU20\_leg [legacy student 20thday]  
 SP\_STUCRS20\_inb [banner student course 20<sup>th</sup>]  
 SP\_STUCRS20\_leg [legacy student course 20<sup>th</sup>]  
 SP\_STUCRSeot\_inb [banner stu course end of term]  
 SP\_STUCRSeot\_leg [legacy stu course end of term]  
 SP\_STUeot\_inb [banner student end of term]  
 SP\_STUeot\_leg [legacy student end of term]

### Student Other Files (SO & SU):

{miscellaneous data related tables}

SO\_GradSch\_OES [Faculty Oral Exam Survey]  
 \*SO\_RevTrf\_CommCol [reverse transfer w comm colleges]  
 \*SU\_adm\_Scores [adm scores upload to Banner 3:55am]  
 \*SU\_adm\_Scores\_wterms [scoresupload to Banner 3:55am]

\* includes table upload to PROD\WSUBIPMS

# Scheduling of BIPM tables (Student BIPMS)

Automated Schedules (SPSS Server):		Manual Schedules (SPSS Client):		Manual non-Scheduled	
time/period	table	time/period	table	time/period	table
2:00	SC_adm_Applications	post 20thday (end of SU)	SC_STU20	(when new codes arrive)	SV_SARD
	SR_adm_Applications_errors		SC_STUCRS20		SV_CCG_course
2:30	SC_adm_Recruits		SC_CRS20		SV_MCG_Majors
	SR_adm_Recruits_errors				SV_payroll_semester_breaks
3:00 (Supplementals 1)		post RO's final grade input per term	SC_STUeot		SV_Poverty_thresholds
	SR_SESF_Audit		SC_STUCRSeot		SV_term_codes
	SV_AAdiv_orgs		SC_CRSeot		SV_Cip_codes
	SS_STUhist_demo				SV_CPI_Income_deflator
	SS_Raceth_inb	post RO's final grade input per term	SR_AtRisk_CRS		SV_adm_AppFreeze_w_eeeknum
	SS_Housing	post RO's final SU posted degrees	SP_Degrees_POS		
	SS_Housing_Applications	end of FY	SS_adm_MFR		
	SS_Payroll	1st Monday of June	SR_QA_FY		
	SS_Finaid	payroll number 24 in November	SS_Faculty_Staff_Nov_Employ		
	SS_Finaid_low_income				
	SS_SARD				
	SS_adm_PreCollegeCurr				
	SS_AFD_ExitSurvey				
	SS_AFD_AlumniSurvey				
	SS_SGRSATT				
	SS_Faculty_GradFaculty				
	SS_Faculty_Sabbaticals				
	SS_Faculty_TenureRank_History				
	SS_Faculty_TenureRank_Latest				
	SS_Faculty_Teaching_History				
3:30 (Supplementals 2)					
	SC_Degrees				
	SS_prevINST				
	SS_enrlhist				
3:45	SC_adm_AppProcessed				
	SU_adm_Scores				
	SU_adm_Scores_w terms				
	SR_AtRisk_Crs				
	SR_AtRisk_STU				
4.00	SR_REGSTUpre20 (seasonal)				
	SR_BIS210IE_pre20th				
	SS_adm_UGnew StuORT (seasonal)				
4:15	SS_GradAppts				
	SR_GradAppts_appt_viol_rpt				
	SR_GradAppts_stu_viol_rpt				
	SR_GradAppts_MissnRecsAudit				
3:25 (Mon)	SP_adm_AppFreeze				
	SR_adm_AppFreeze				
4:50 (SC_STU_CRS_current)					
	SC_STUcur				
	SC_STUCRScur				
	SC_CRScur				

# SC\_adm\_Recruits [Core] Admissions (UG, IE, GR) Banner Recruits (Incoming)

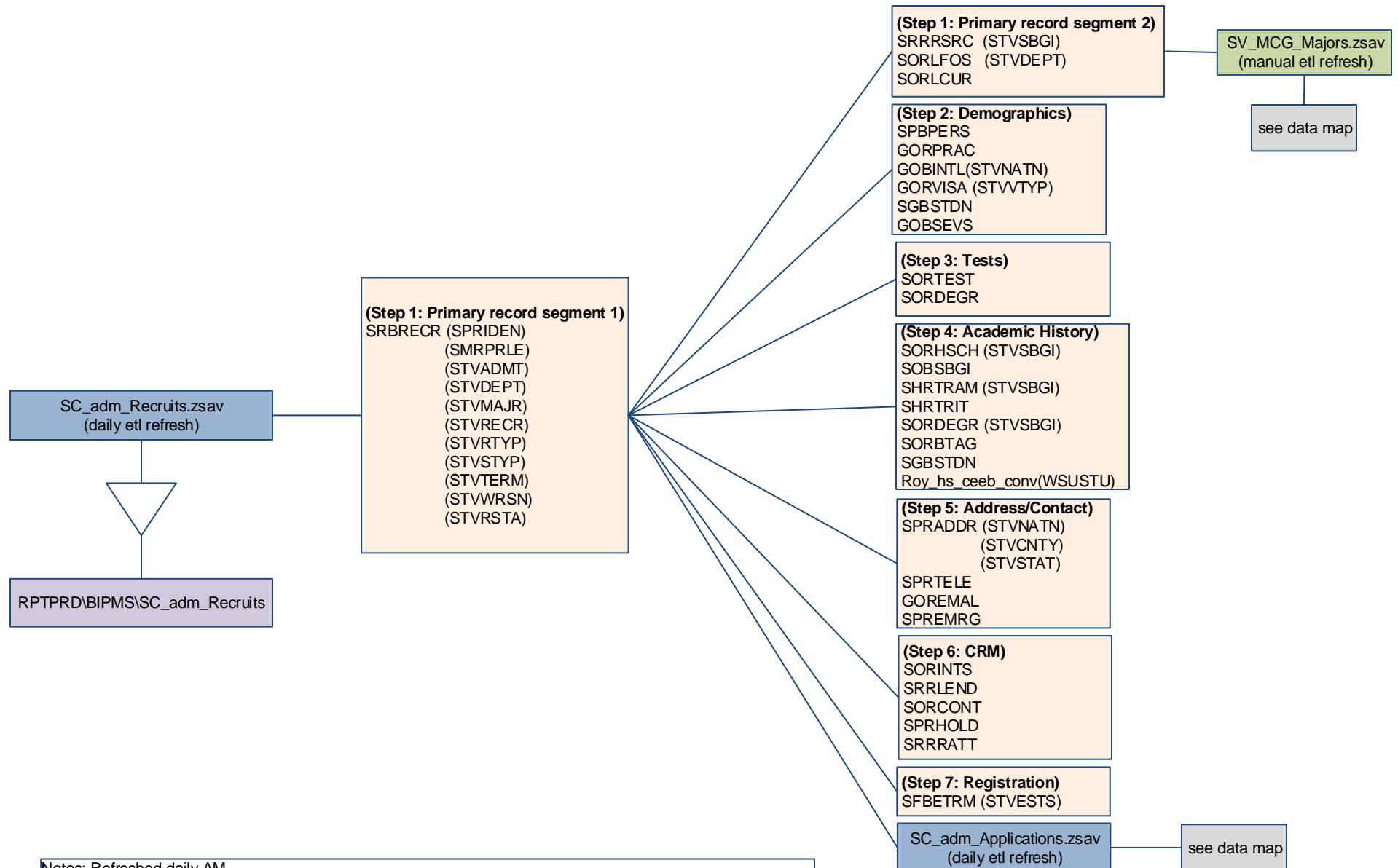

Notes: Refreshed daily AM.  
 Master recruit table pulling directly from PROD, includes all recruit activity in SRBRECR & related tables.  
 RPTPRD indexes on SRBRECR\_PIDM & SRBRECR\_TERM\_CODE  
 Revised 02/04/2015.

# SC\_adm\_Applications [Core]

## Admissions (UG,IE,GR) Banner Applications (Incoming)

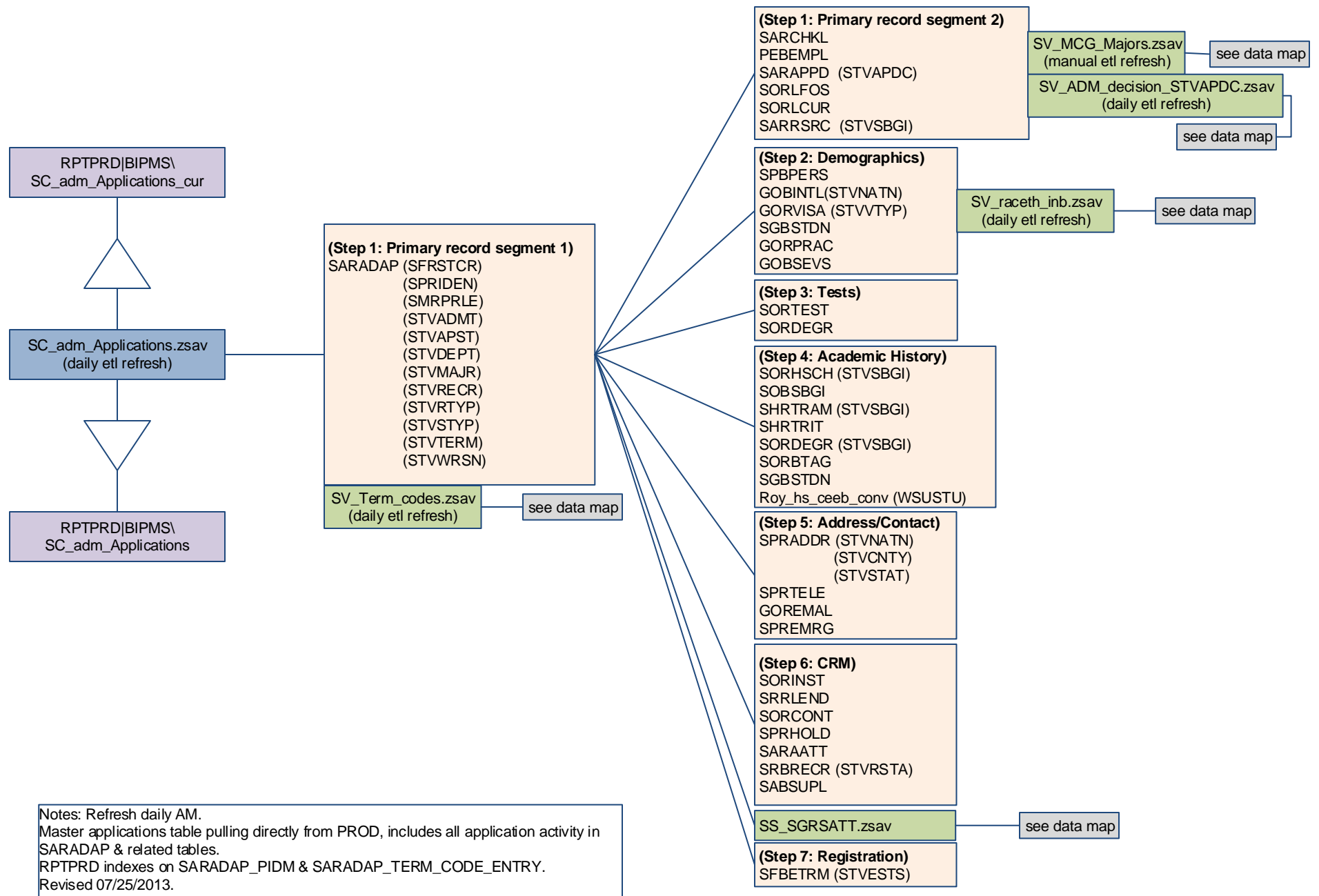

Notes: Refresh daily AM.  
 Master applications table pulling directly from PROD, includes all application activity in SARADAP & related tables.  
 RPTPRD indexes on SARADAP\_PIDM & SARADAP\_TERM\_CODE\_ENTRY.  
 Revised 07/25/2013.



# SC\_adm\_AppProcessed [Core] Admissions (UG,IE,GR) Banner & Legacy Processed Applications (Incoming)

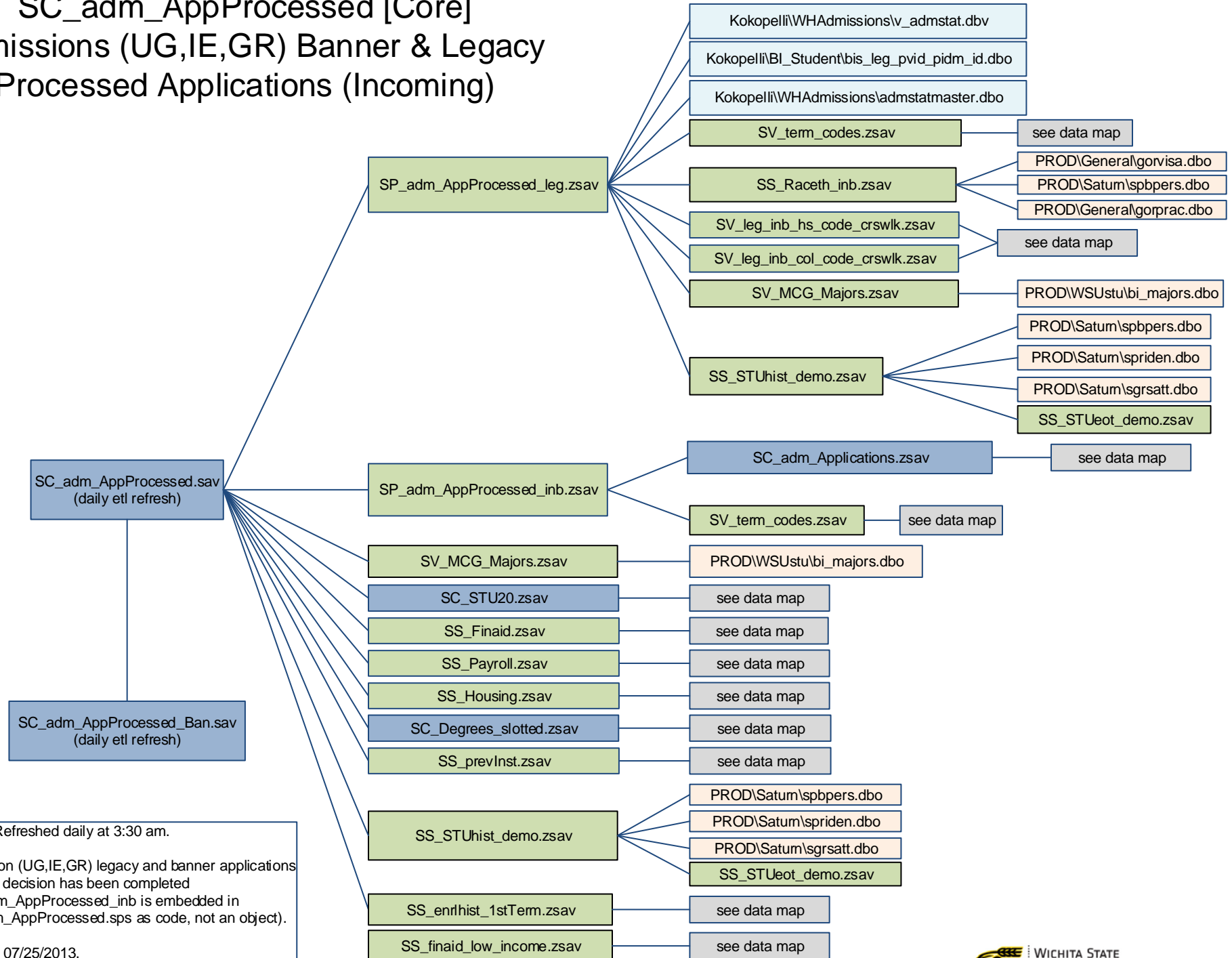

Notes: Refreshed daily at 3:30 am.  
Admission (UG,IE,GR) legacy and banner applications where a decision has been completed (SP\_adm\_AppProcessed\_inb is embedded in SC\_adm\_AppProcessed.sps as code, not an object).  
Revised 07/25/2013.

# SC\_STUcur (Core) Student Enrollment Current Term (In-Process)

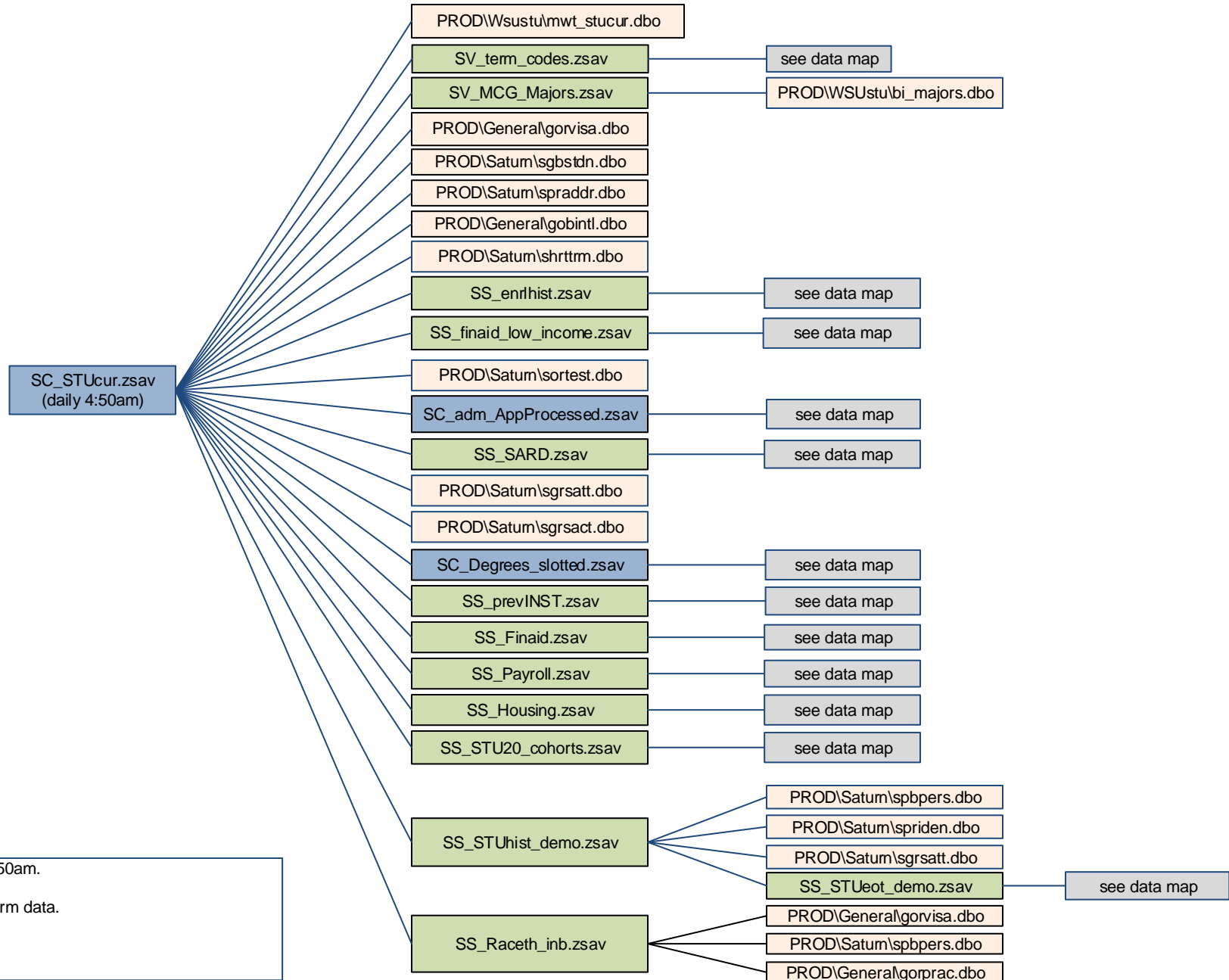

Notes: Daily refresh at 4:50am.  
Banner student current term data.  
Revised 07/29/2013.

# SC\_STU20 [Core] Student Enrollment 20<sup>th</sup> day (In-Process)

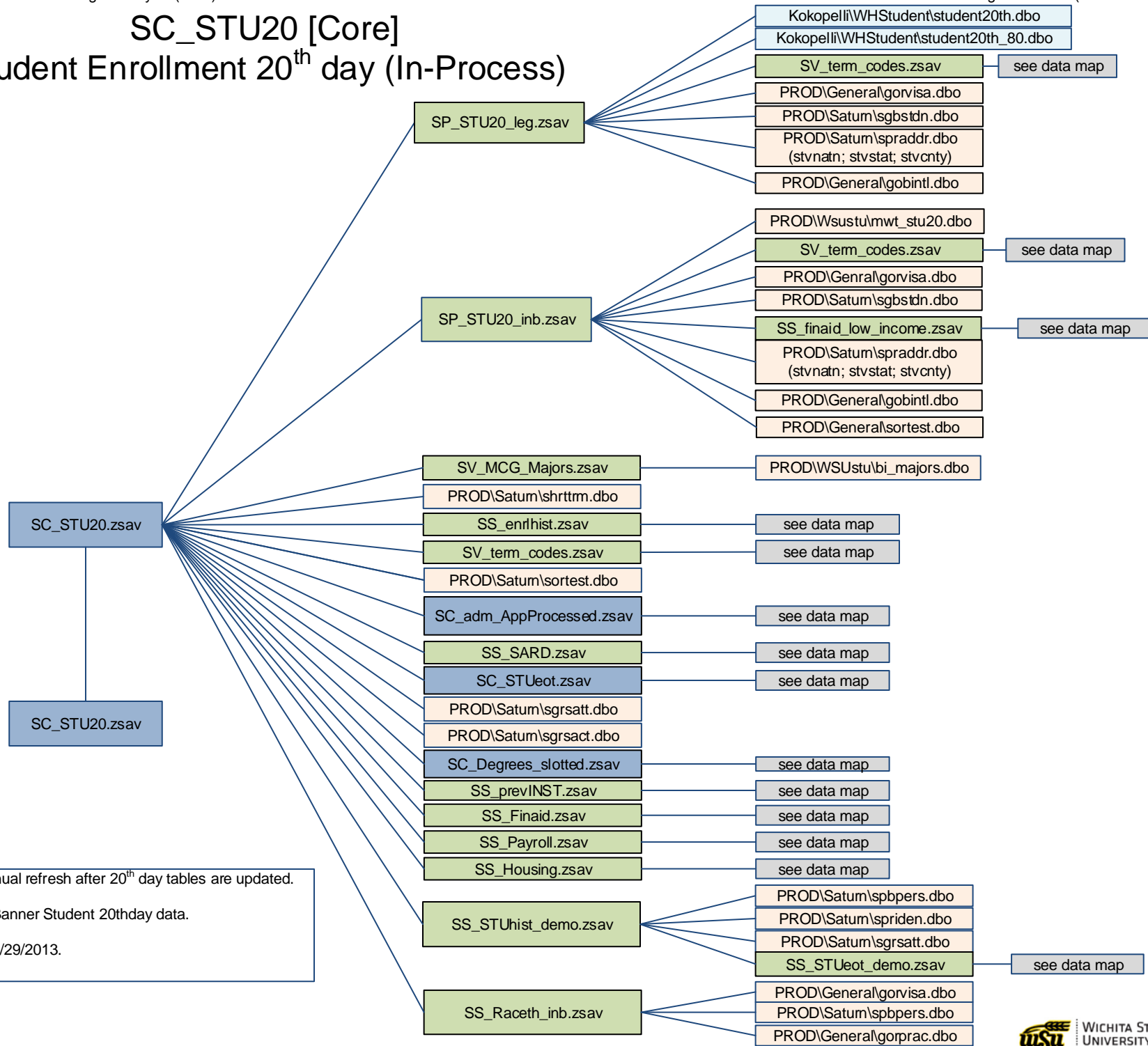

Notes: Manual refresh after 20<sup>th</sup> day tables are updated.  
 Legacy & Banner Student 20thday data.  
 Revised 07/29/2013.

# SC\_STUeot [Core] Student Enrollment End of Term (In-Process)

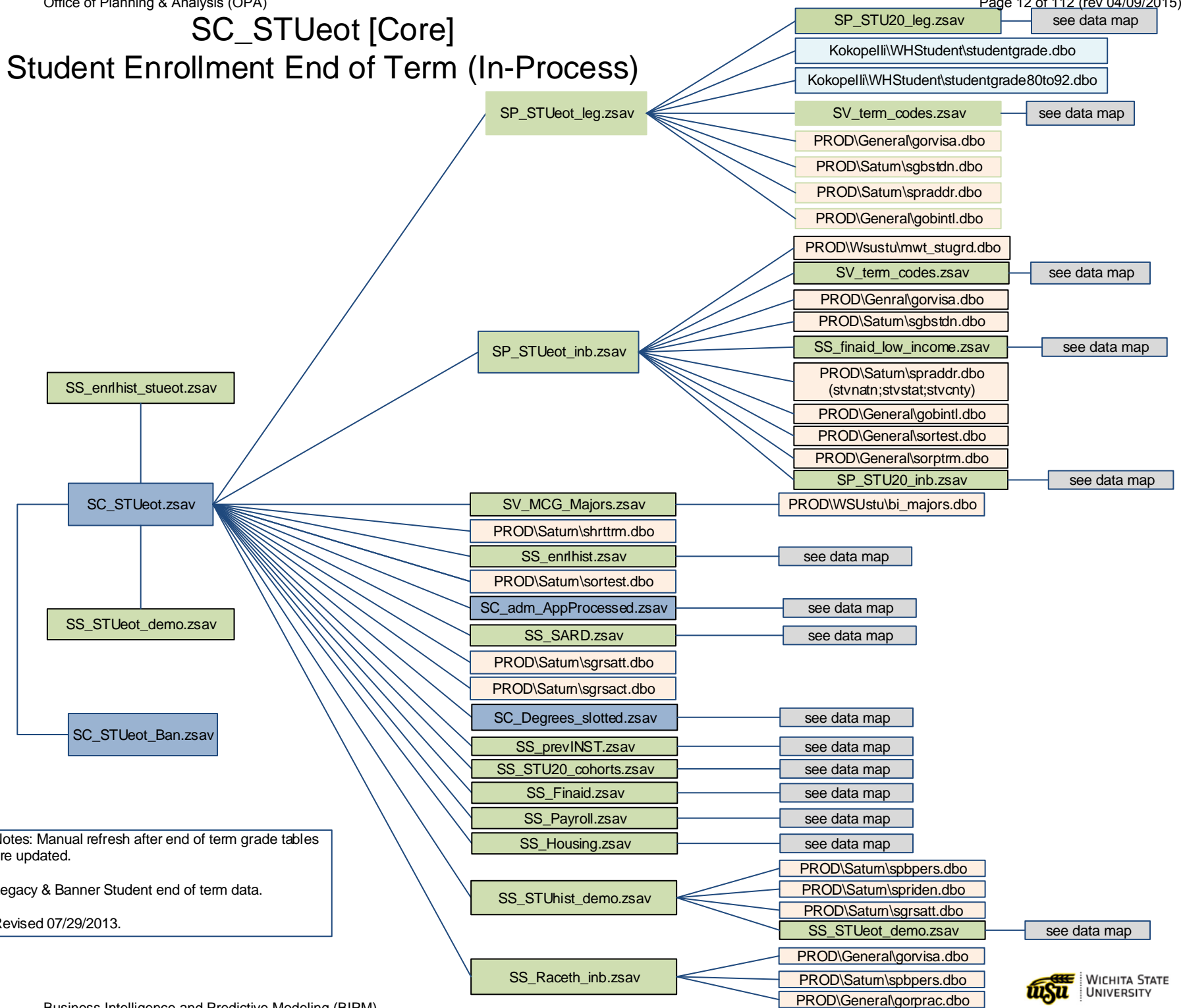

Notes: Manual refresh after end of term grade tables are updated.  
 Legacy & Banner Student end of term data.  
 Revised 07/29/2013.

# SC\_STUCRScur [Core] Student by Course Current Term (In-Process)

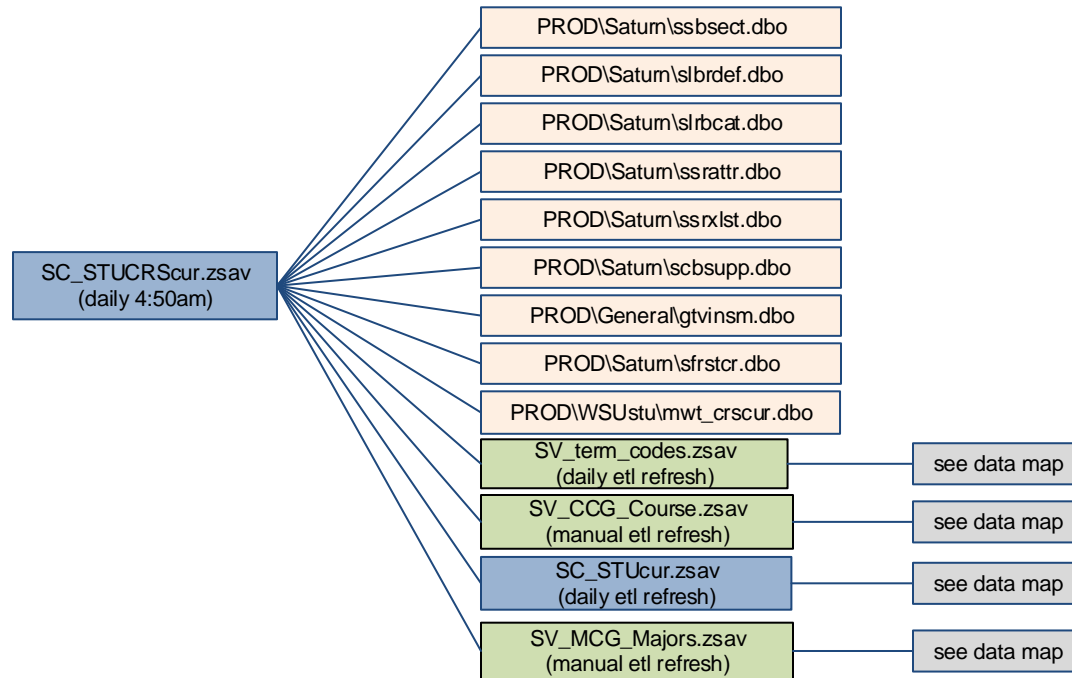

Notes: Refresh daily AM.

Banner current term combined student/course (crn) data. Student is the unit of analysis within a course crn.

Revised 02/04/2015.

# SC\_STUCRS20 [Core] Student by Course 20thday (In-Process)

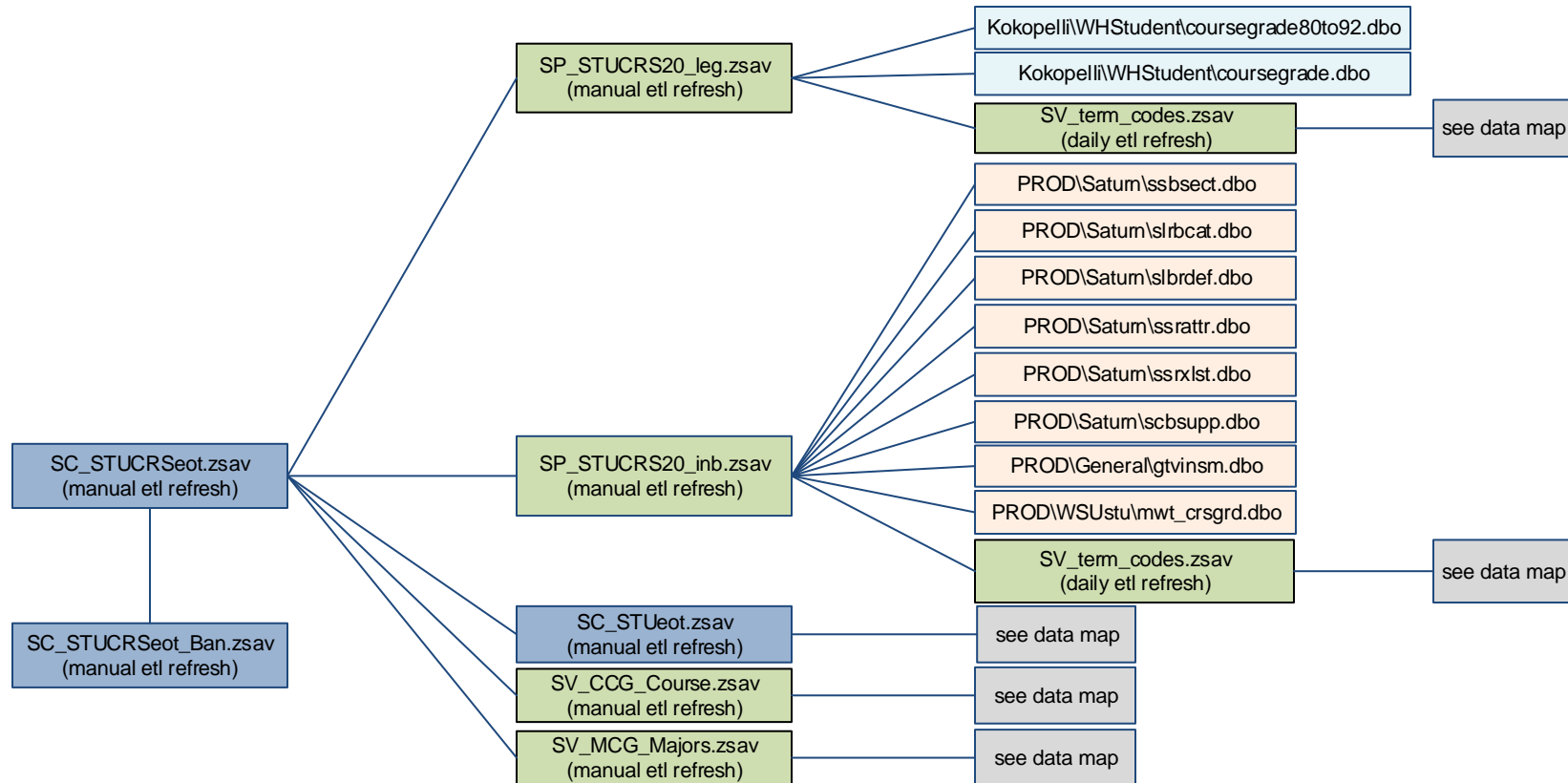

Notes: Manual update when 20thday tables are refreshed every term.  
 Legacy and Banner 20thday combined student/course (crn) data. Student is the unit of analysis within a course crn.  
 Revised 07/29/2013.

# SC\_STUCRSeot [Core]

## Student by Course End of Term (In-Process)

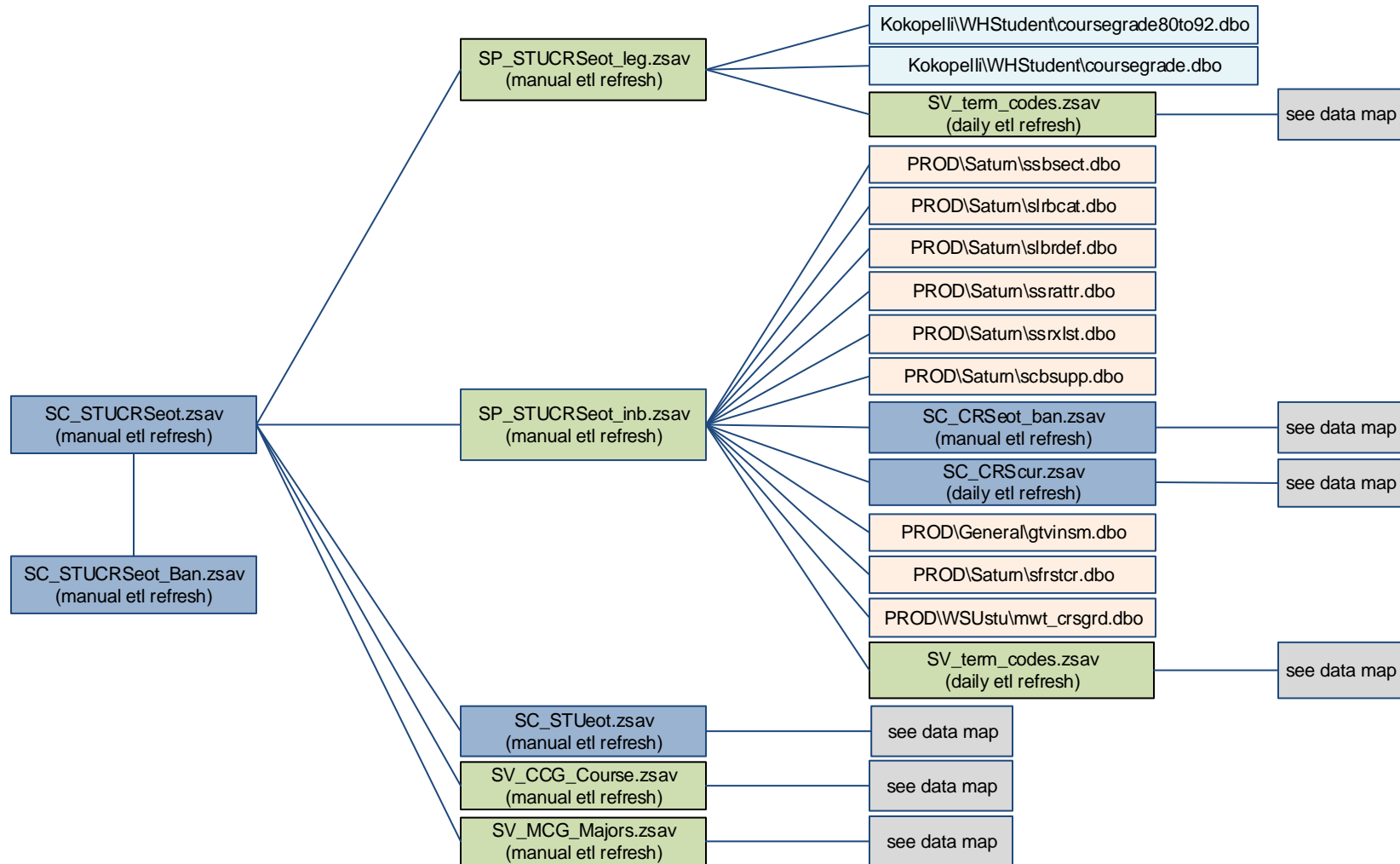

Notes: Manual update when end of term tables are refreshed every term.  
 Legacy and Banner end of term combined student/course (crn) data. Student is the unit of analysis within a course crn.  
 Revised 07/29/2013.

# SC\_CRScur [Core] Course Level (CRN) Current Term (In-Process)

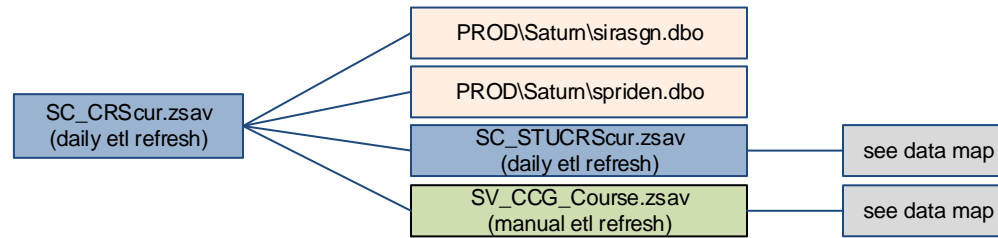

Notes: Refresh daily AM.  
Banner course-level (crn is unit of analysis) current term data.  
Revised 08/02/2013.



# SC\_CRS20 [Core] Course Level (CRN) 20<sup>th</sup> day (In-Process)

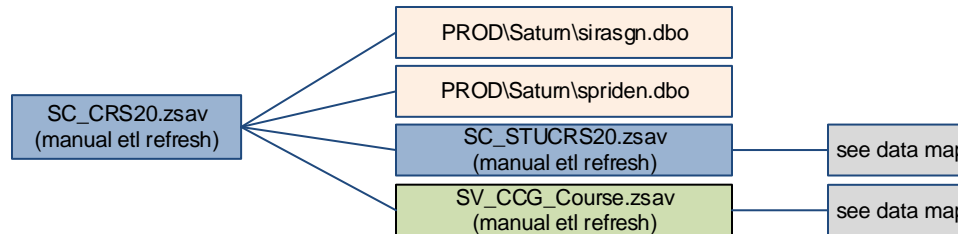

Notes: Manually updated after 20<sup>th</sup> day term tables are refreshed.  
Legacy and Banner course-level (crn is unit of analysis) 20thday data.  
Revised 08/02/2013.

# SC\_CRSeot [Core] Course Level (CRN) End of Term (In-Process)

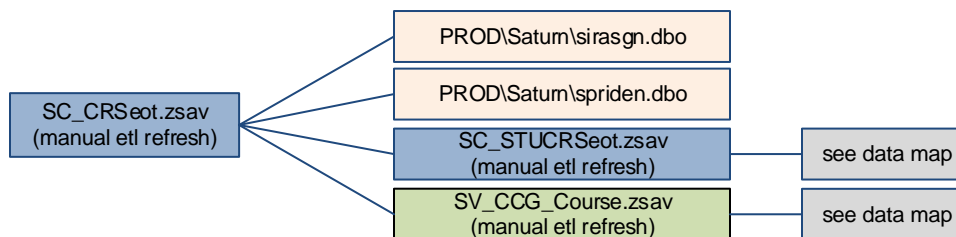

Notes: Manually refreshed after end of term tables are refreshed.  
Legacy/Banner end of term course-level (crn is unit of analysis) data.  
Revised 08/02/2013.

# SC\_Degrees [Core] Degrees Completed (Outgoing)

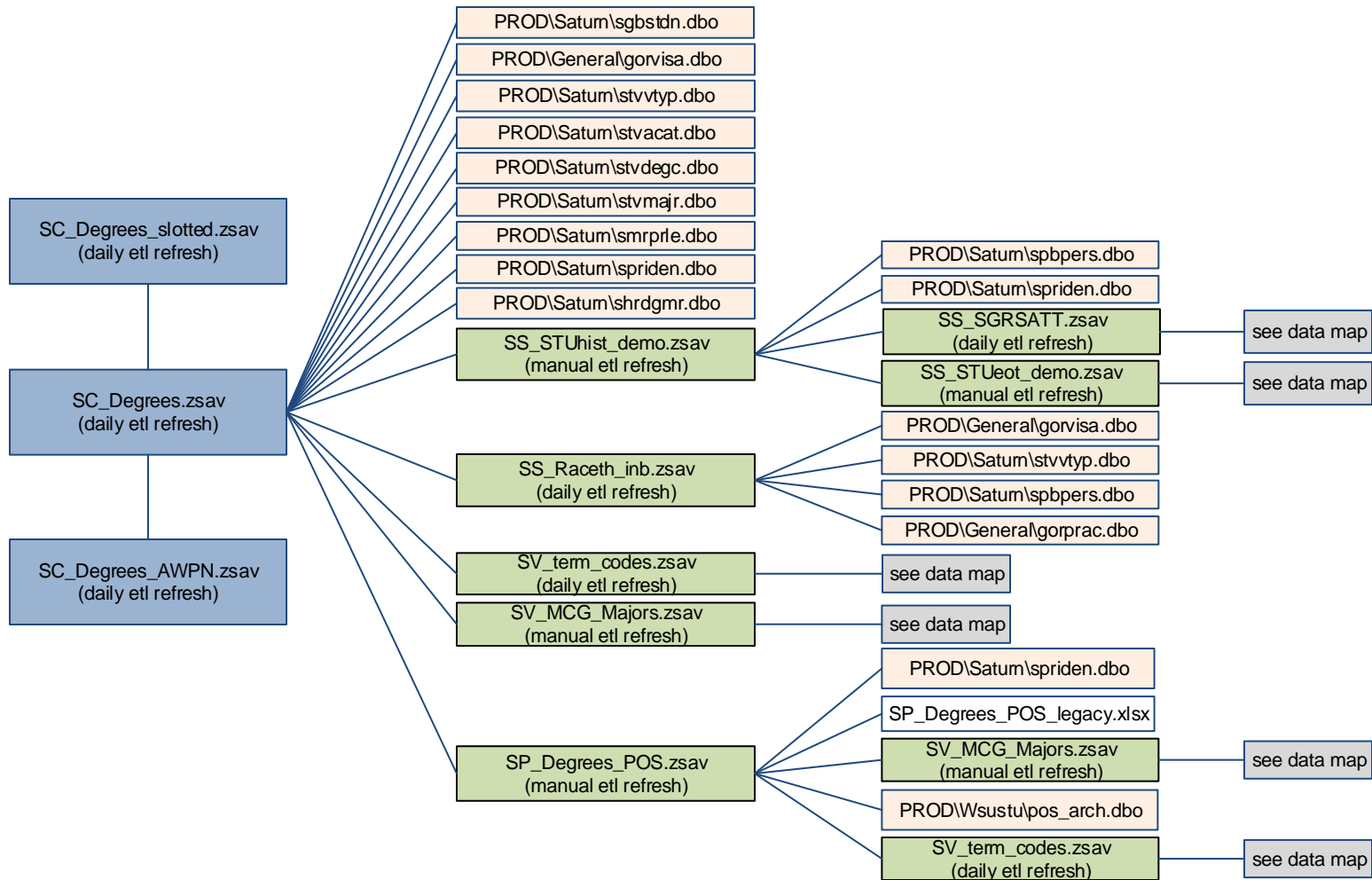

Notes: Refresh daily AM.

Provides completed degrees (UG & GR) throughout WSU history. SC\_Degrees is slotted at end of job completion for alternative supplemental joins to create SC\_Degreed\_slotted.

Revised 02/04/2015.

# SO\_GradSch\_OES [Other] Graduate School Faculty Oral Exam Survey



Notes: Manually updated as new survey data arrives in OPA.

Graduate School surveys the outside committee member of all thesis/dissertation defenses.

Revised 08/02/2013

# SO\_RevTrf\_CommCol [Other] Associate Degree Reverse Transfer Agreement

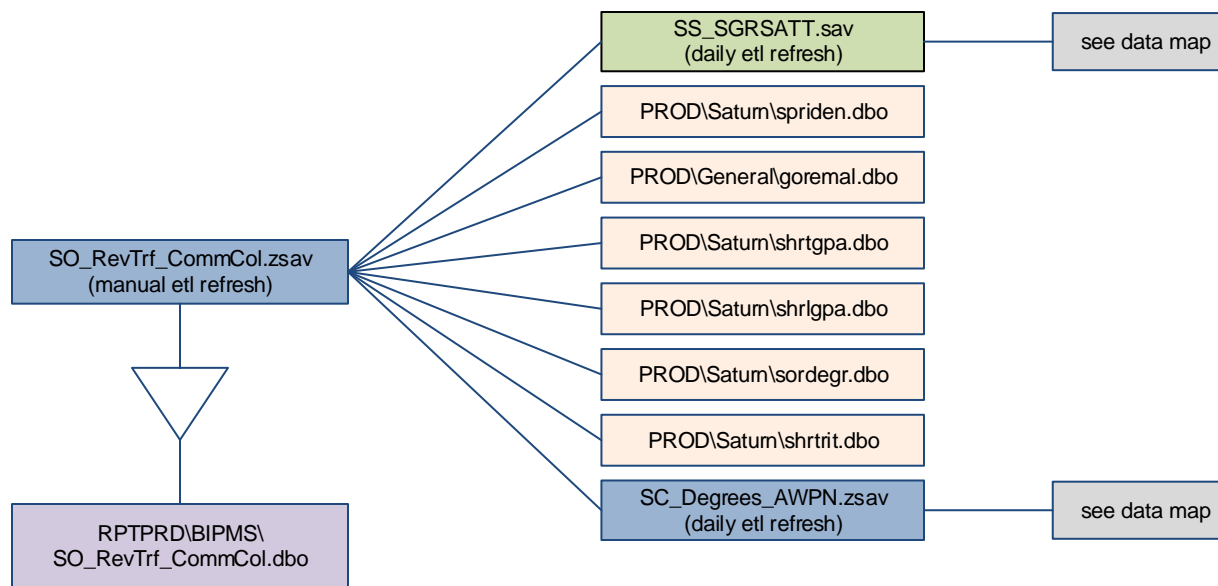

Notes: Manual  
Identifies eligible students for associate degree reverse transfer with community colleges.  
RPTPRD index on PIDM.  
Revised 02/03/2015.

# SO\_SR\_MeritSchl [Other]

## HS Senior (SR) Merit Scholarships

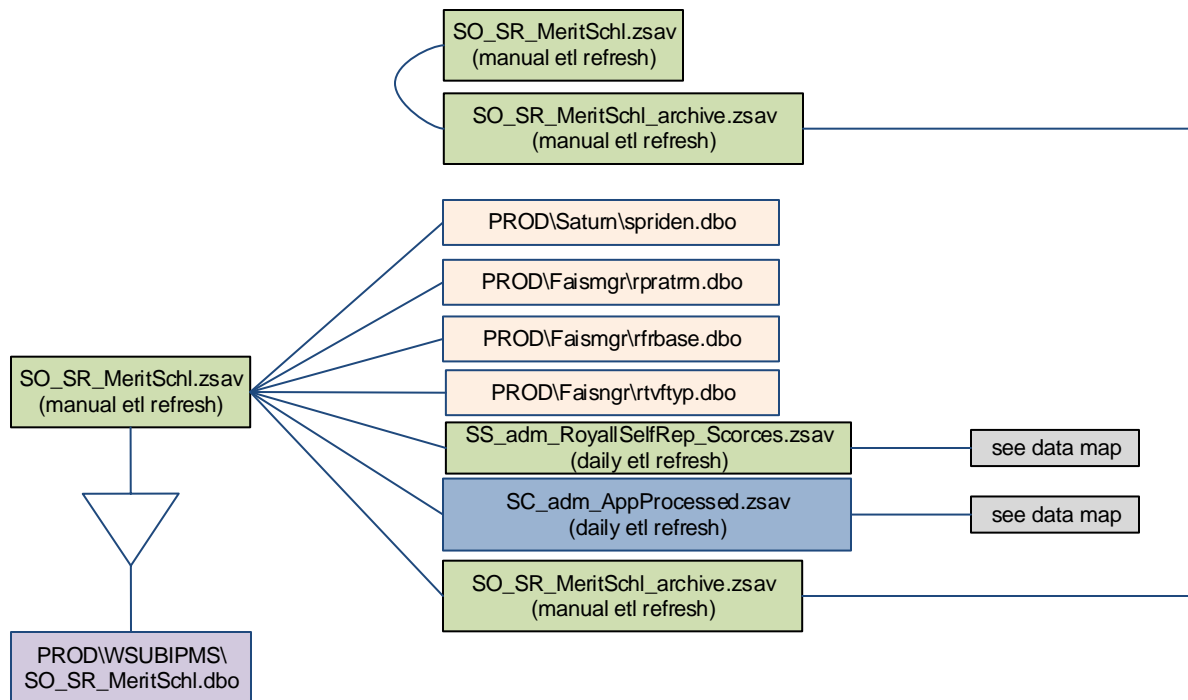

Notes:  
High School Seniors (SR) Merit Scholarship table that provides data for ITS (Jeff Bever) to load into FAISMGR for scholarship tables.

Revised 02/03/2015.

# SP\_adm\_AppFreeze [PreStage] Admissions Applications Freeze (Incoming)

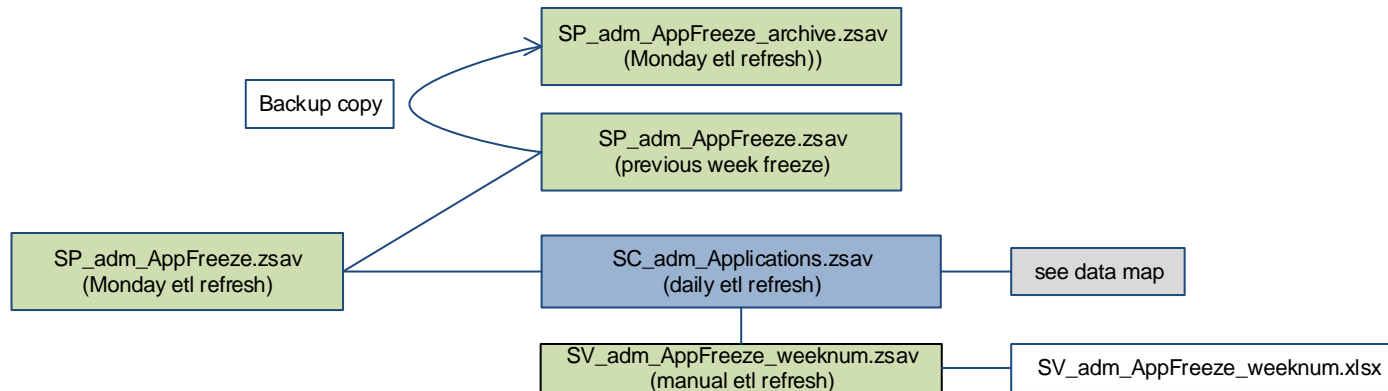

Notes:  
Banner admissions (UG,IE,GR) applications freeze every Monday.  
Previous week freeze is archived in case of job failure, new application data from BIPMS\_adm\_applications is frozen for current week data & combined with previous week freeze data to provide the current week freeze table.  
Revised 02/02/2015

# SP\_adm\_AppProcessed\_inb [PreStage] Banner Applications Processed (Incoming)

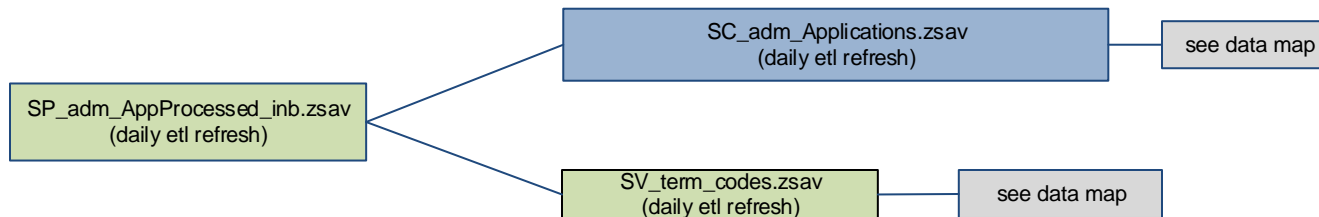

Notes: Refresh daily AM;  
Banner admission (UG,IE,GR) applications where an admission decision has been completed. Feeds SC\_adm\_AppProcessed (code for SP\_adm\_AppProcess\_inb is embedded in SC\_adm\_AppProcessed syntax file).  
Revised 02/02/2015.



# SP\_adm\_AppProcessed\_leg [PreStage] Legacy Applications Processed (Incoming)

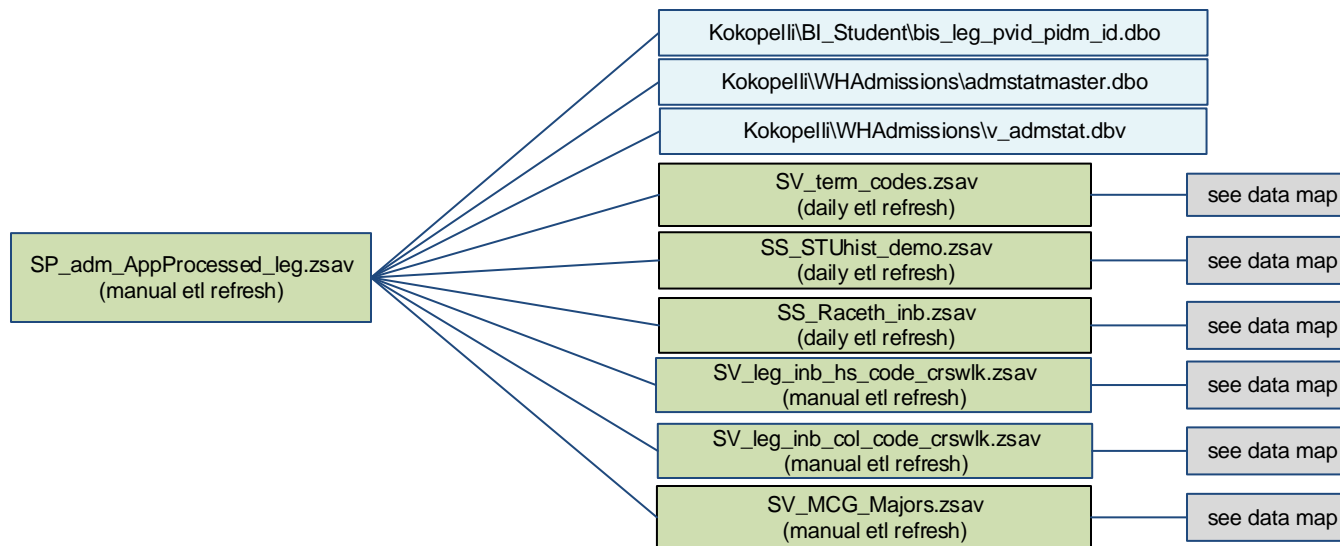

Notes:  
Legacy admissions (UG,IE,GR) applications where an admission decision has been completed. Feeds SC\_adm\_AppProcessed. Manually ran whenever legacy revision has occurred.

Revised 02/02/2015

# SP\_Degrees\_POS [PreStage] Graduate Student Plan of Study (POS)

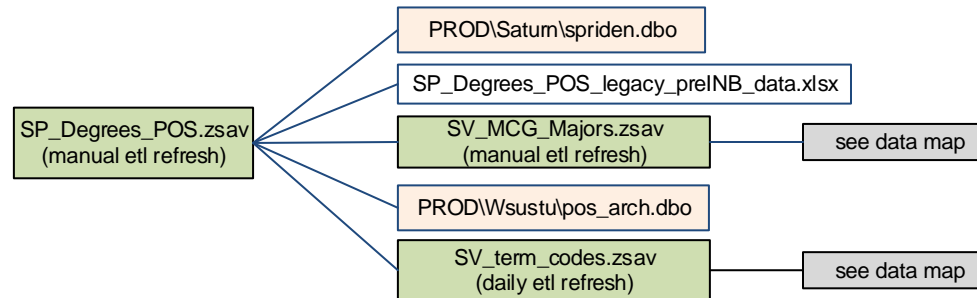

Notes:  
Updated at the end of the summer session for each academic year once the registrar office clears summer degrees & UCATS (Jacobs) runs the batch process to clear the CAPP temporary tables to refresh PROD\Wsustu\pos\_arch.

This table joins to SC\_Degrees to provide time to degree for graduate students who complete a degree.

Revised 08/02/2013.

## SP\_EnrHist\_STUeot [PreStage] End of Term Activity for SS\_EnrHist

See SC\_STUeot for SP\_enrlhist\_stueot.zsav mapping

Notes: Manually updated whenever SC\_STUeot is refreshed; captures all end of term activity from 1980 to present with major for use in SS\_ENRLHIST build..

Revised 02/02/2015.

# SP\_Faculty\_Teaching\_History\_Legacy [PreStage] Legacy Teaching History for INB SS\_Faculty\_Teaching\_History

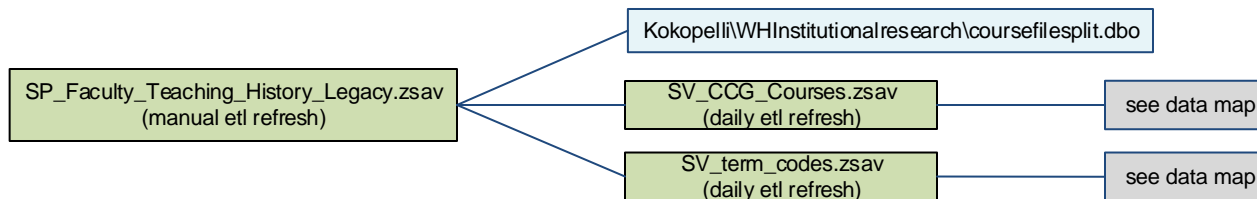

Notes: Manually updated whenever a revised is made for legacy Financial aid data.  
Feeds SS\_FinAid table. Provides legacy based financial aid data from summer of 1980.  
Revised 02/02/2015.

# SP\_Finaid\_leg [PreStage] Legacy Student Financial Aid

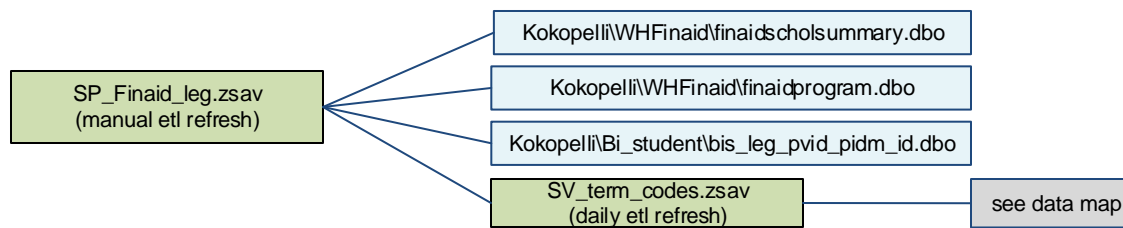

Notes: Manually updated whenever a revised is made for legacy Financial aid data.  
Feeds SS\_FinAid table. Provides legacy based financial aid data from summer of 1980.  
Revised 08/02/2013.

# SP\_Payroll\_inb [PreStage] Banner Student Payroll

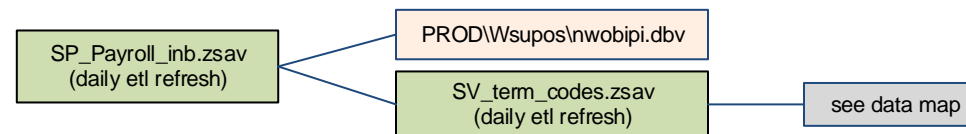

Notes: Updated daily via SS\_Payroll.sps, code for SP\_Payroll\_inb execution is embedded in SS\_Payroll.sps. Previous source was PROD\wsu\_bis\_payroll\_inb.

Banner based student (UG & GR) payroll data, feeds SS\_Payroll table.

Revised 08/02/2013.

# SP\_Payroll\_leg [PreStage] Legacy Student Payroll

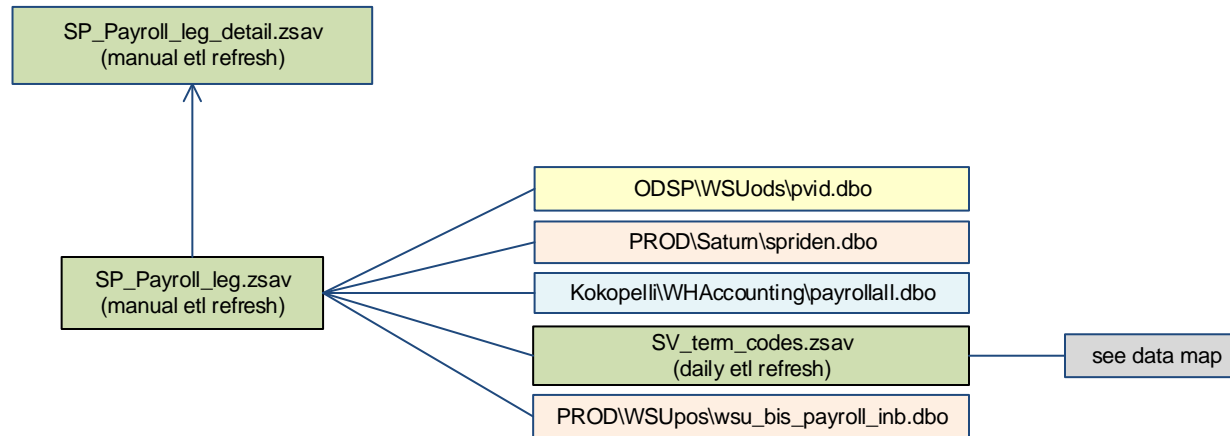

Notes: Manual update whenever revisions occur to legacy data.  
Legacy based student (UG & GR) payroll data, feeds SS\_Payroll table.  
Revised 08/02/2013.

# SP\_REGSTUpre20\_archive [PreStage] Pre-20thday Daily Registration Archive (In-Process)

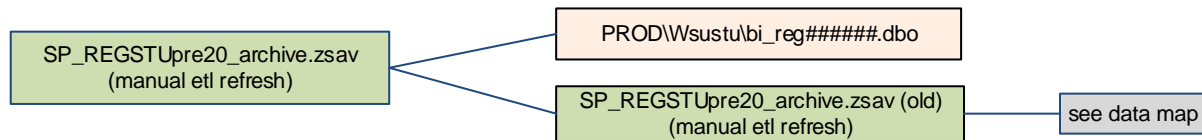

Notes: Manual update every end of pre-registration term.  
REGSTUpre20\_archive feeds SR\_REGSTUpre20 table.  
Revised 08/02/2013.



# SP\_STU20\_inb [PreStage] Banner Student Enrollment 20<sup>th</sup> day (In-Process)

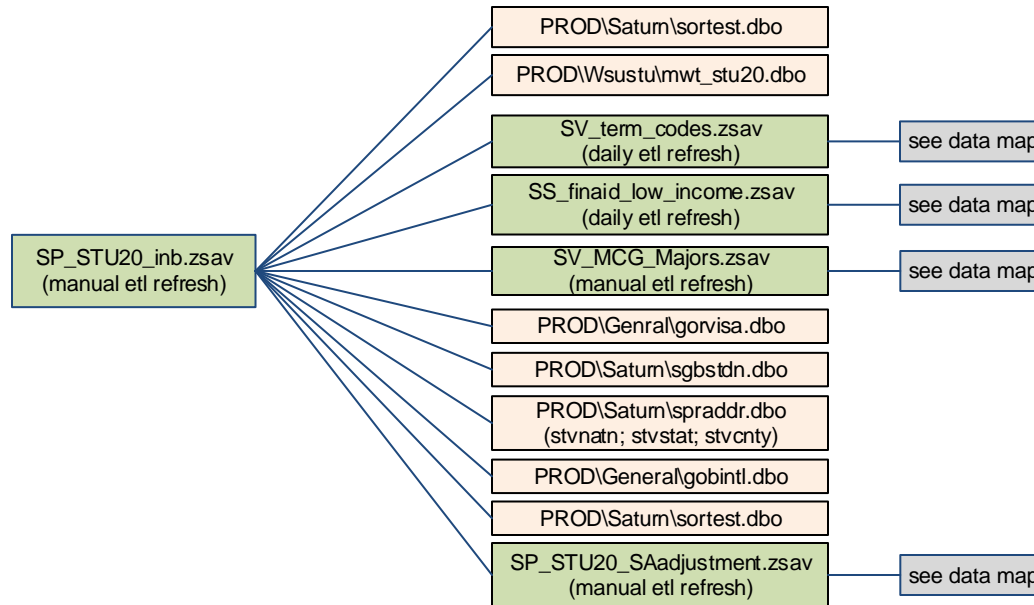

Notes: Manual update once every term that MWT\_STU20 is refreshed.  
Banner 20thday Student data, feeds SC\_STU20 table.  
Revised 02/01/2015.

# SP\_STU20\_leg [PreStage] Legacy Student Enrollment 20thday

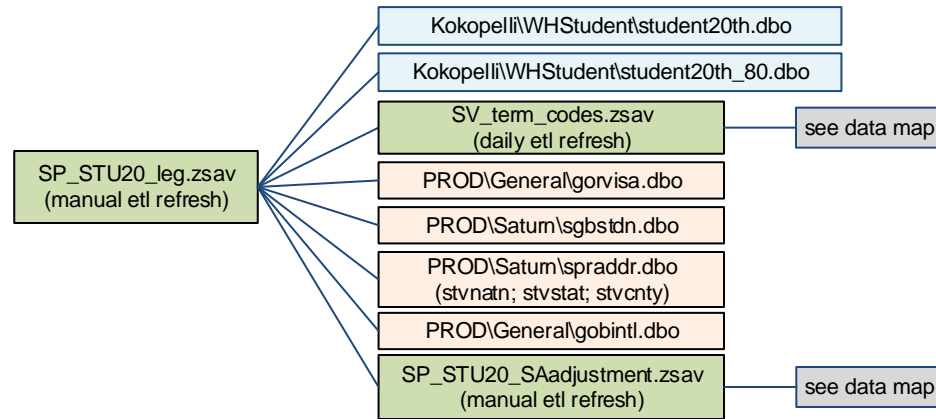

Notes: Manual refresh whenever legacy data or code changes.  
Legacy 20thday student data, feeds SC\_STU20 table.  
Revised 02/01/2015.

# SP\_STU20\_SAadjustment [PreStage]

## Adjust Enrolled Hours of Senior Citizens

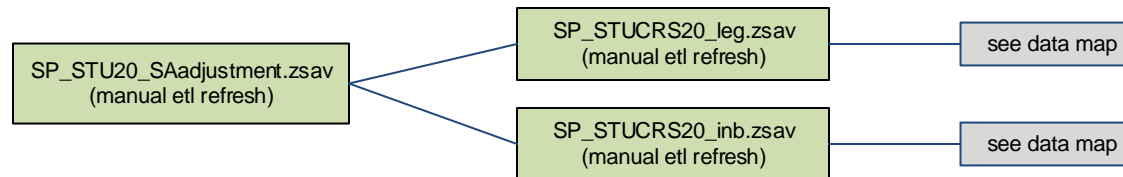

Notes: Adjusts senior citizen hours in past STUeot frozen tables to report SA hours that were pre 2013 not counted to KBOR.

Revised 01/30/2015.

# SP\_STUCRS20\_inb [PreStage] Banner Student in Course Enrollment 20<sup>th</sup> day (In-Process)

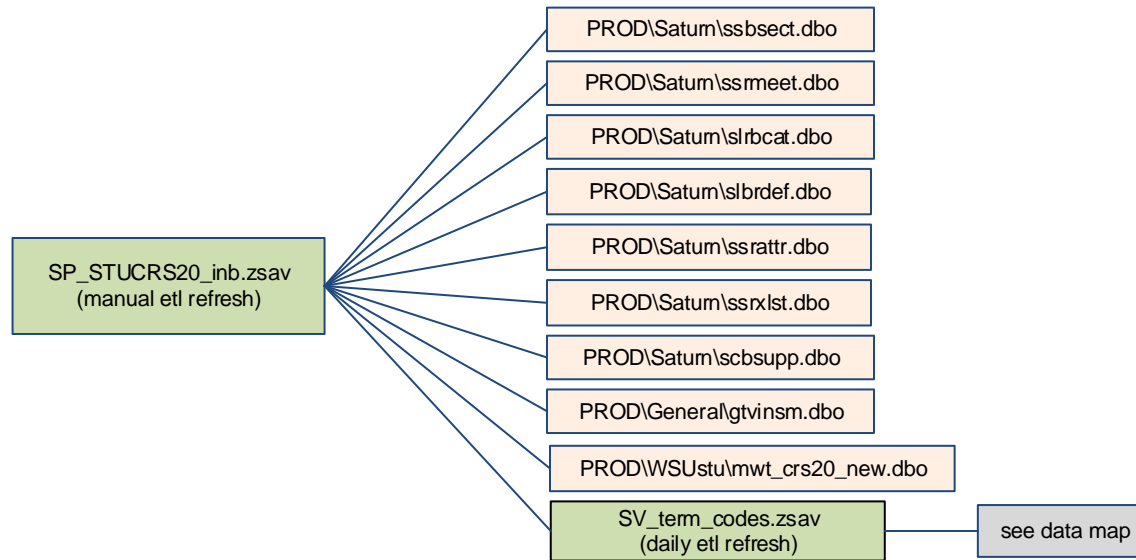

Notes: Manual update once MST\_CRS20\_NEW is refreshed every term.  
Banner 20thday combined student/course (crn) data, feeds SC\_STUCRS20 table (student is unit of analysis within cm)  
Revised 07/29/2013.

# SP\_STUCRS20\_leg [PreStage] Legacy Student in Course Enrollment 20<sup>th</sup> day (In-Process)

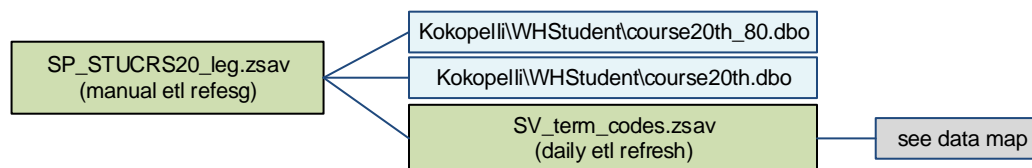

Notes: Manual update whenever legacy data or code is revised.  
Legacy 20thday combined student/course (crn) data, feeds SC\_STUCRS20 table (student is unit of analysis within cm)  
Revised 07/29/2013.

# SP\_STUCRSeot\_inb [PreStage] Banner Student in Course Enrollment End of Term (In-Process)

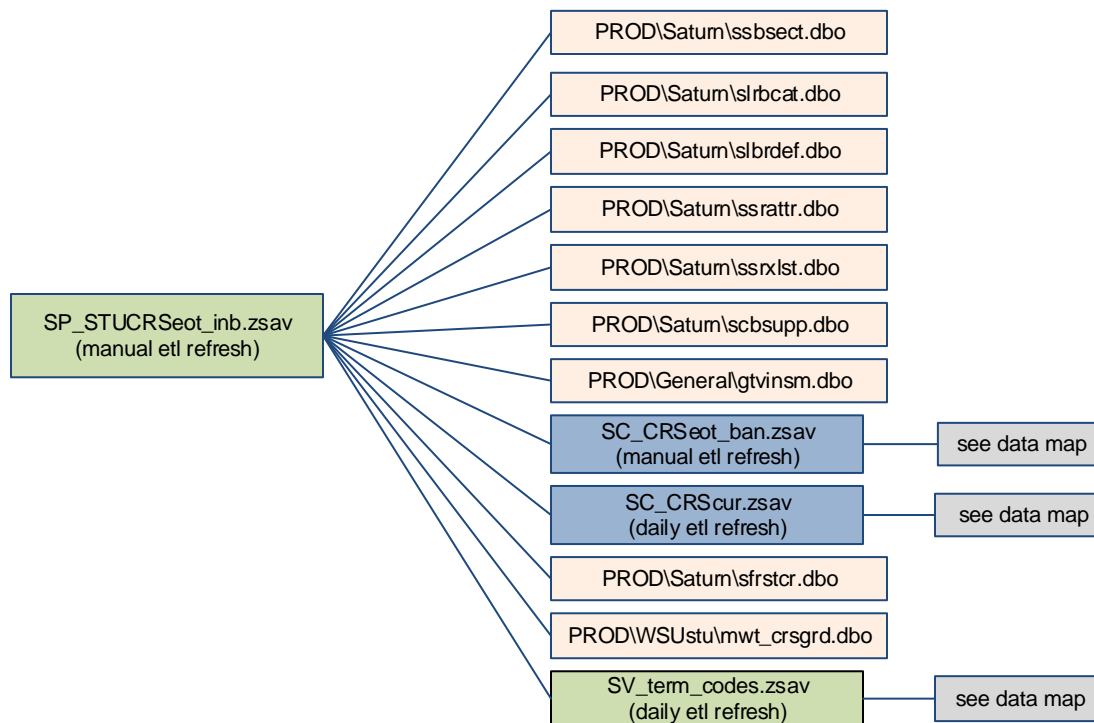

Notes: Manual update when end of term MWT\_CRSGRD refreshed.

Banner end of term combined student/course (crn) data, feeds SC\_STUCRSeot table (student is unit of analysis with crn).

Revised 07/29/2013.

# SP\_STUCRSeot\_leg [PreStage] Legacy Student in Course Enrollment End of Term (In-Process)

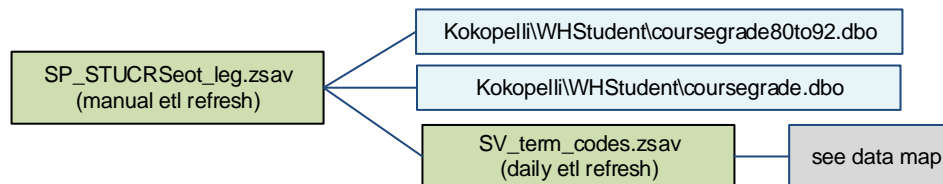

Notes: Manual update whenever legacy data or code is revised.  
Legacy end of term combined student/course(crn) data, feeds SC\_STUCRSeot table (student is unit of analysis within cm)  
Revised 07/29/2013.

# SP\_STUeot\_inb [PreStage] Banner Student Enrollment End of Term (In-Process)

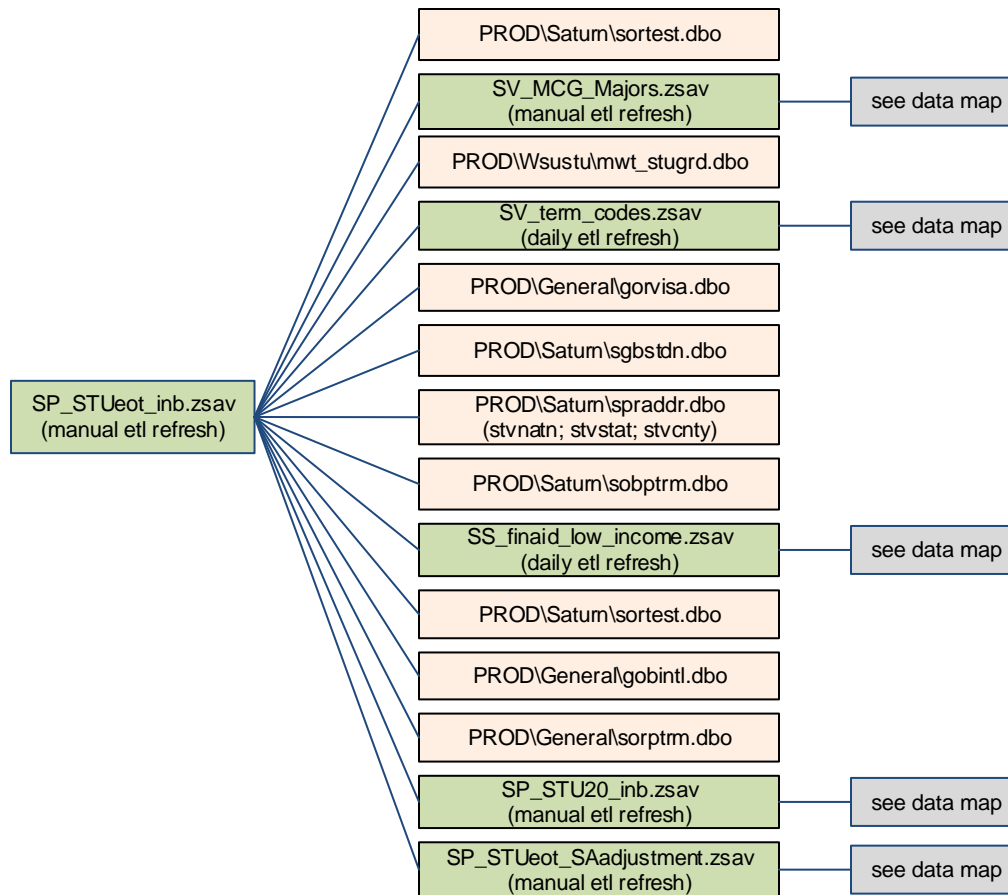

Notes: Manual update every end of term once MWT\_STUGRD is refreshed.  
Banner end of term student data, feeds SC\_STUeot table.  
Revised 01/30/2015.



# SP\_STUeot\_leg [PreStage] Legacy Student Enrollment End of Term (In-Process)

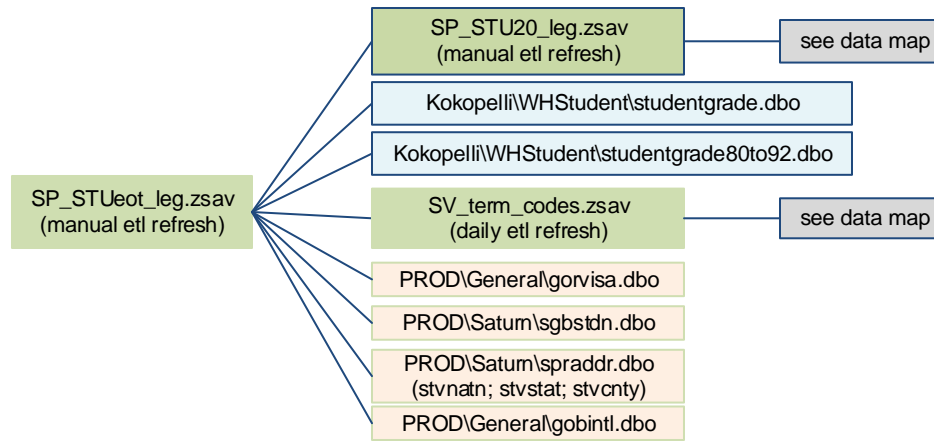

Notes: Manual update of legacy end of term data when warranted.

Revised 07/29/2013.

# SP\_STUeot\_SAadjustment [PreStage]

## Adjust Enrolled Hours of Senior Citizens

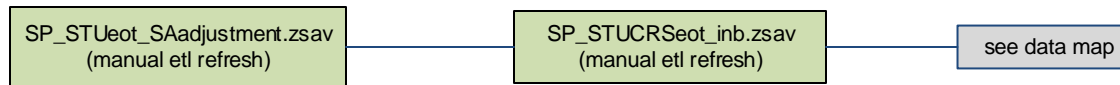

Notes: Adjusts senior citizen hours in past STUeot frozen tables to report SA hours that were pre 2013 not counted to KBOR.

Revised 01/30/2015.

# SR\_adm\_AppFreeze [Reporting] Weekly Student Application Freeze (Incoming)

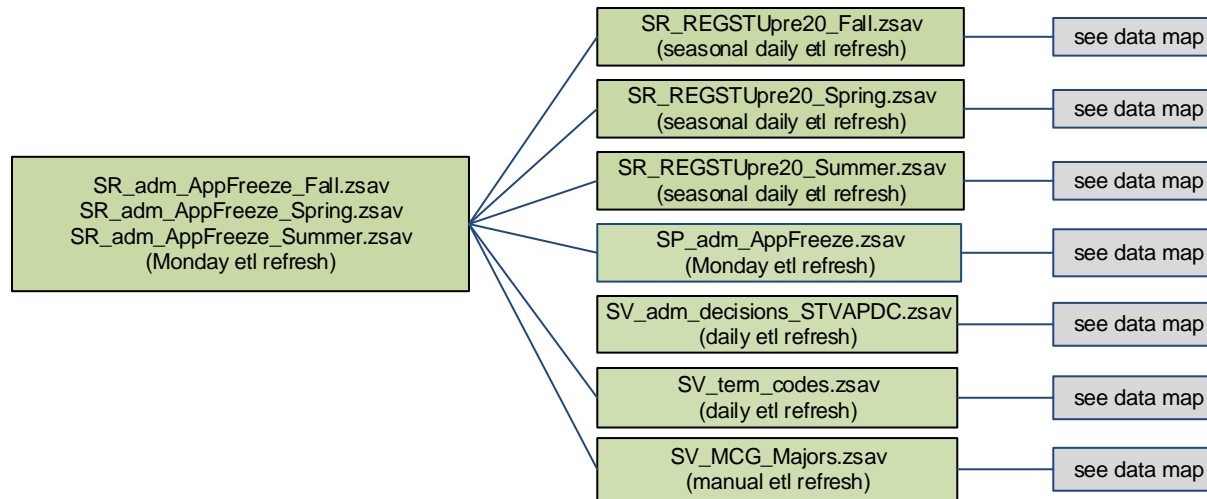

Notes: Refresh every Monday AM.

Admission (UG,IE,GR) applications weekly freeze slices (banner only), feeds the BIS0310 graph set and admission feeder reports.

Revised 01/29/2015.

# SR\_adm\_Applications\_Errors [Reporting] Data Entry Errors for SC\_adm\_Applications

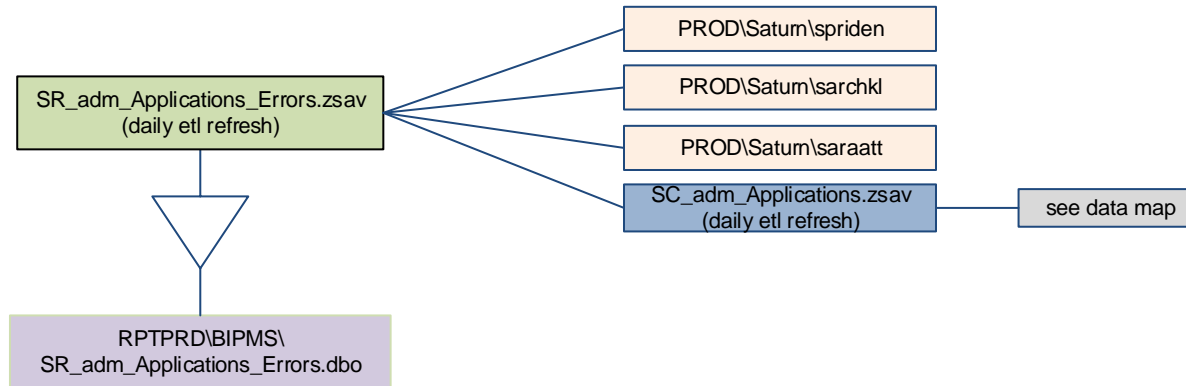

Notes: Refresh daily AM.  
Identifies data entry errors in SC\_adm\_Applications for UG, IE & GR admission offices. Reporting Services pulls from RPTPRD for daily report excel attachment delivery.  
RPTPRD index on ADM\_OFFICE.  
Revised 01/29/2015.

# SR\_adm\_Recruits\_Errors [Reporting] Data Entry Errors for SC\_adm\_Recruits

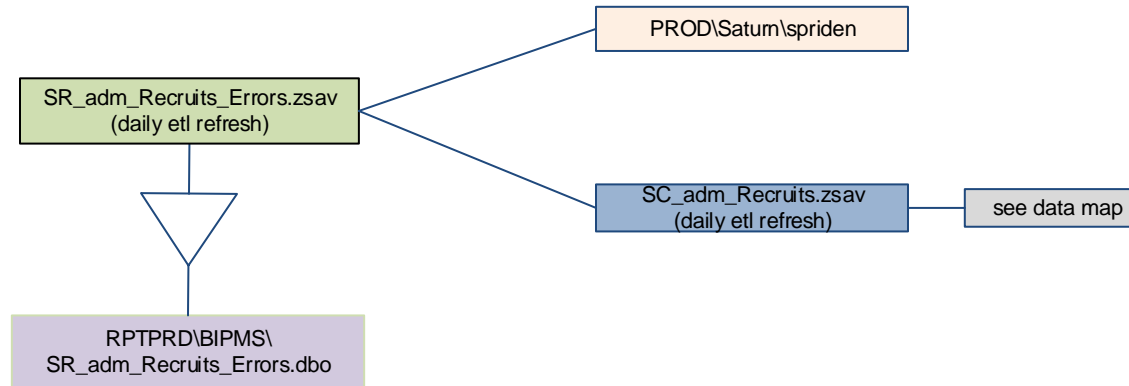

Notes: refresh daily AM.  
Identifies data entry errors in SC\_adm\_Recruits for UG, IE & GR admission offices. Reporting Services pulls from RPTPRD for daily report excel attachment delivery.  
RPTPRD index on ADM\_OFFICE.  
Revised 01/29/2015.

# SR\_AtRisk\_CRS [Reporting] Course Level High DF Grades

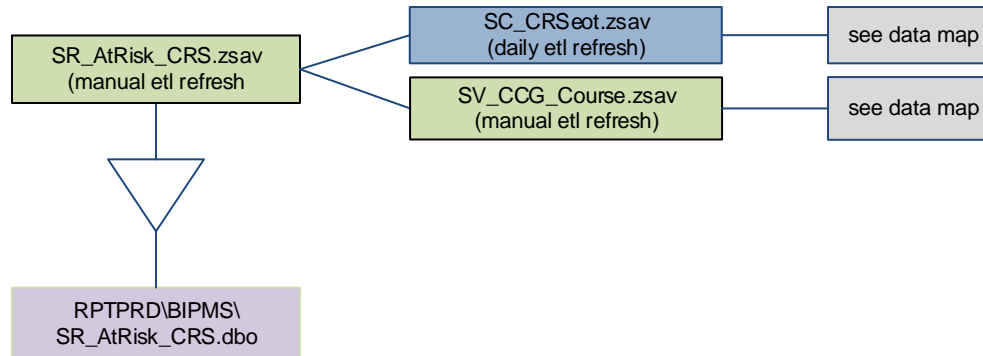

Notes: Manually updated at the end of each semester once grades have been posted to create 3 year rolling average.  
Feeds SR\_AtRisk\_STU table providing the list of courses whose 3 year rolling averages have high D/F grade distributions, becomes part of the BIS\_01000\_Student AtRisk report.  
RPTPRD index on CRS\_SUBJCATA  
Revised 01/29/2015.

# SR\_AtRisk\_STU [Reporting] Student At Academic Risk (Incoming & In-process)

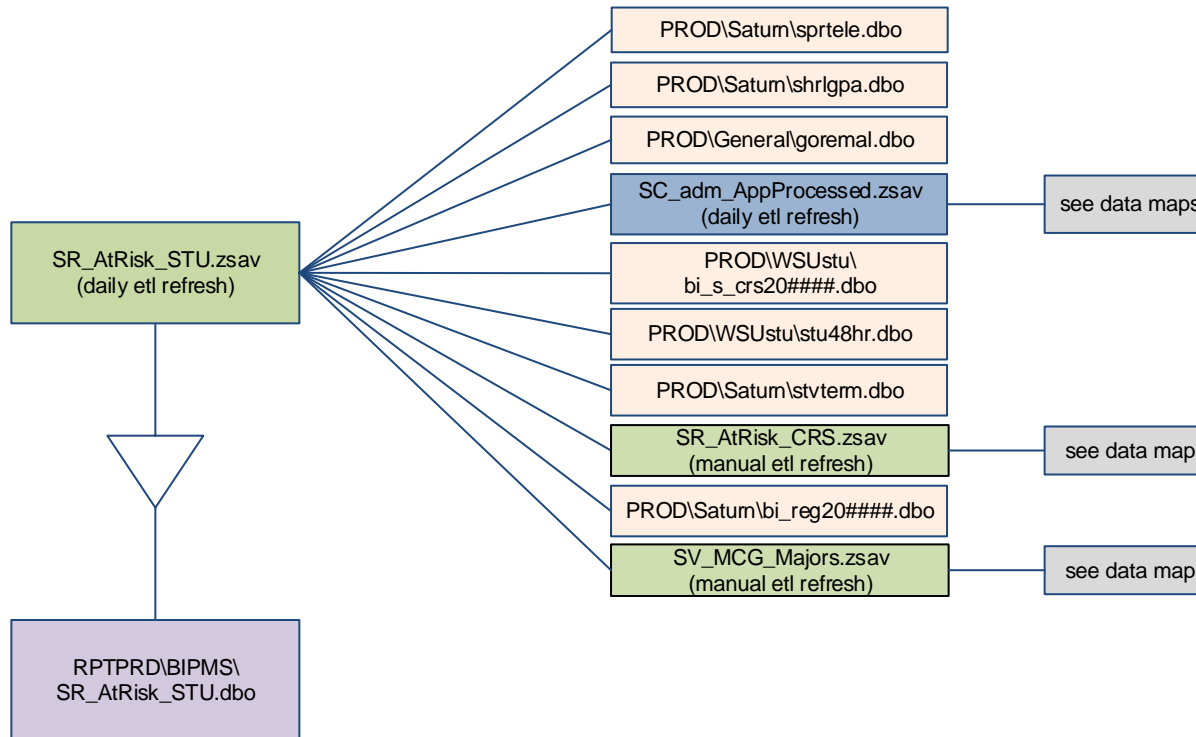

Notes: refresh daily am.  
 Provides data for the BIS01000 Student At Risk reports to display whether student's incoming academic skill places them at academic risk, includes registration in high DF courses and in-process academic standing.  
 RPTPRD index on PIDM.  
 Revised 01/29/2015.

# BIS210IE\_Pre20th\_Reg [Reporting]

## BIS210 Series Pre-registration of Foreign Student Only

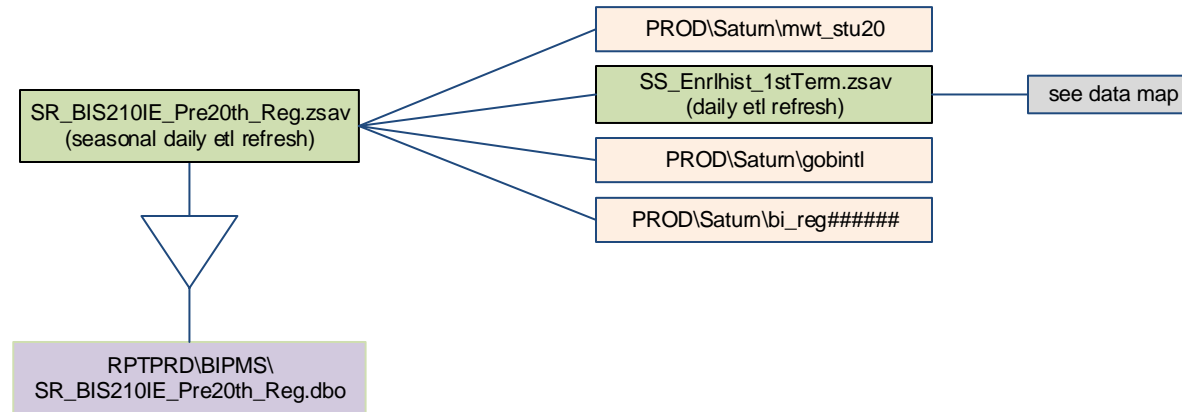

Notes: Refresh daily during pre20th day registration (am).  
Replicates part of BIS210 series but for only Foreign students adding data from previous 20thday reports for International Education.  
RPTPRD index on PIDM.

Revised 01/28/2015.



# SR\_GradAppts\_appt\_viol\_rpt [Reporting] Graduate Appointment Violations – Appointment level

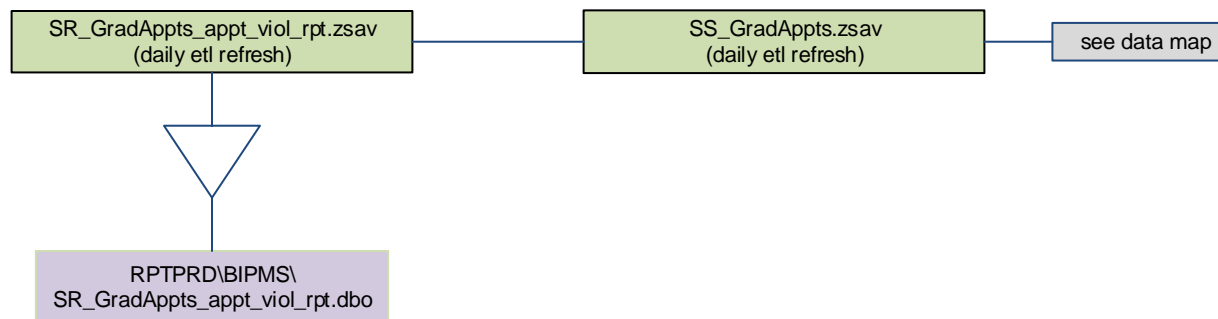

Notes: refreshed daily am.  
Identifies appointment level violations or data entry errors on SS\_GradAppts.  
RPTPRD index on VIOLATION

Revised 01/28/2015

# SR\_GradAppts\_MissnRecsAudit [Reporting] PWRGACT and NBRJOBS records match

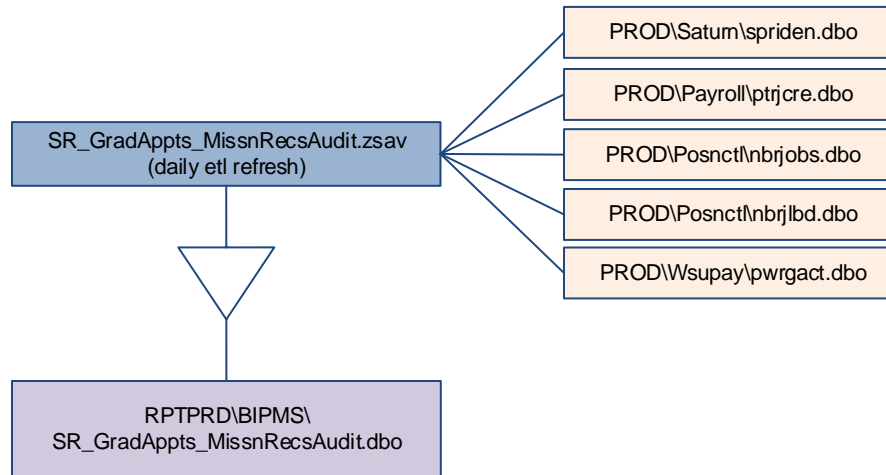

Notes: refresh daily am.  
Audits PWRGACT to determine whether NBRJOBS are missing.  
RTPRD index on POSN\_EFFDATE.  
Revised 01/28/2015.

# SR\_GradAppts\_stu\_viol\_rpt [Reporting] Graduate Appointment Violations – Student level

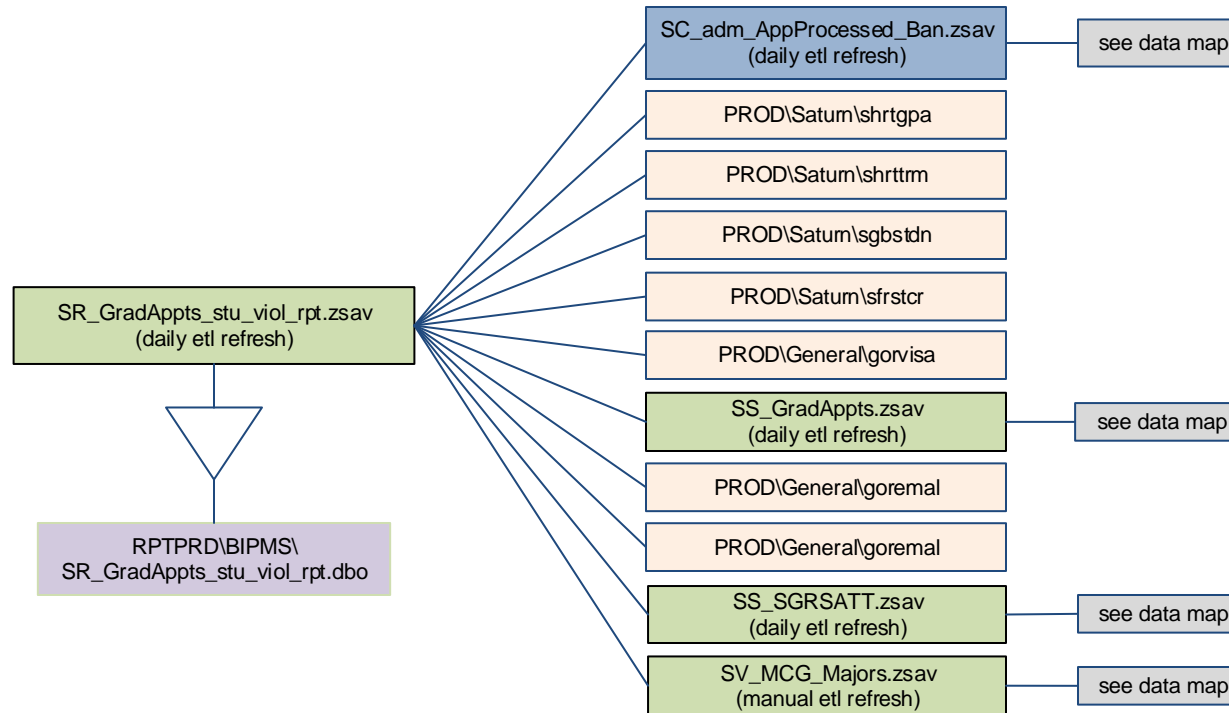

Notes: refreshed daily am  
 Identifies student level violations or data entry errors on SS\_GradAppts.  
 RPTPRD index on VIOLATIONS

Revised 01/28/2015

## BIS\_QA\_FY\_archive & BIS\_QA\_FY\_freeze (BIS-Banner) Qualified Admissions (Incoming)

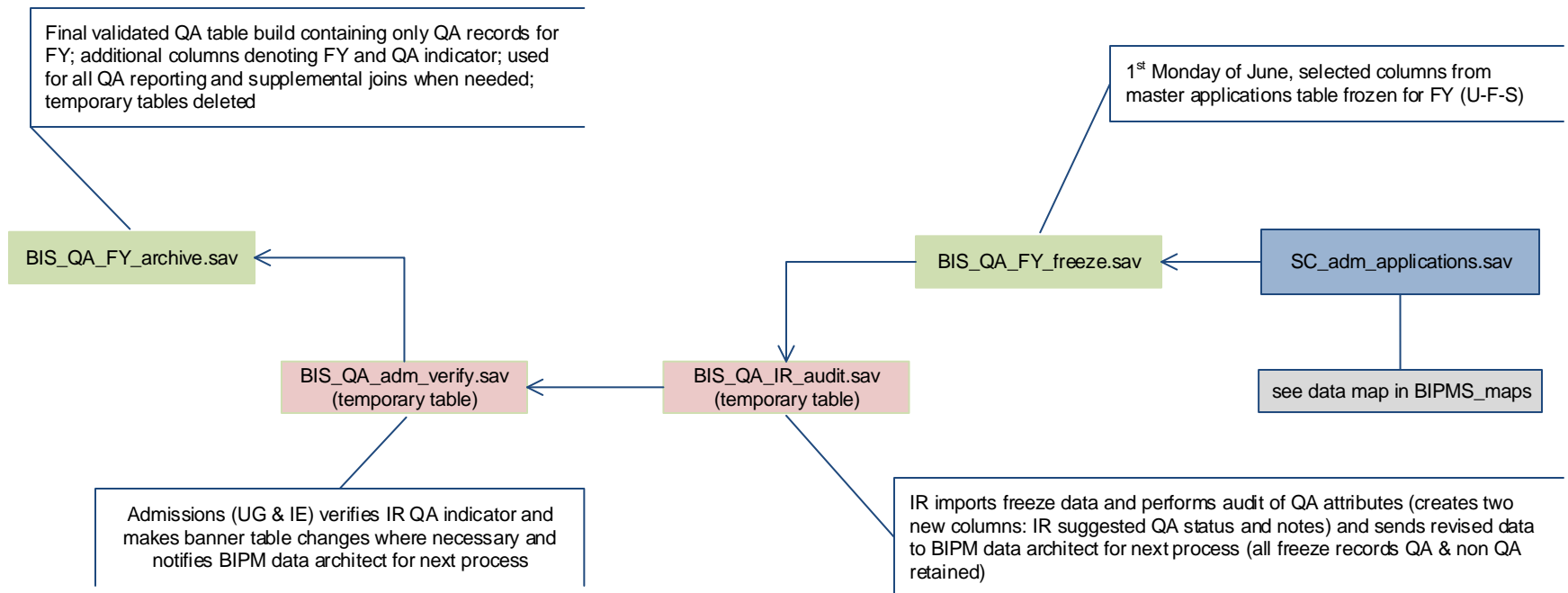

Notes: (manual execution in June)  
 BIS\_QA\_FY\_archive is used for reporting QA activity by FY and for joins as supplemental data to other BIPM & non\_BIPM tables for analysis.

Revised 06/12/2011

# SR\_REGSTUpre20 [Reporting] Pre-20<sup>th</sup> day Daily Registration

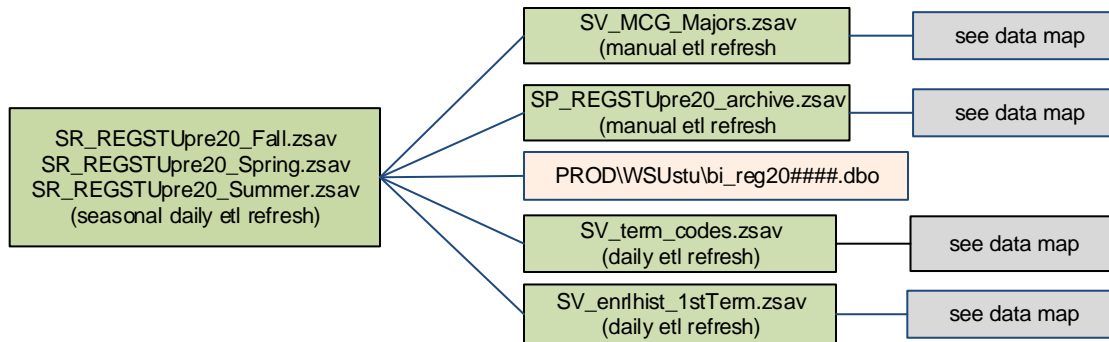

Notes: Refreshed daily during pre20th daya registration activity.  
Student daily registration data (banner only), provides data for BIS0210 series Daily Registration Reports and extracts aggregated last student registration pre-20thday per term.  
Revised 01/28/2015.

# SR\_SESF\_Audit [Reporting] Spoken English Screening Form Compliance

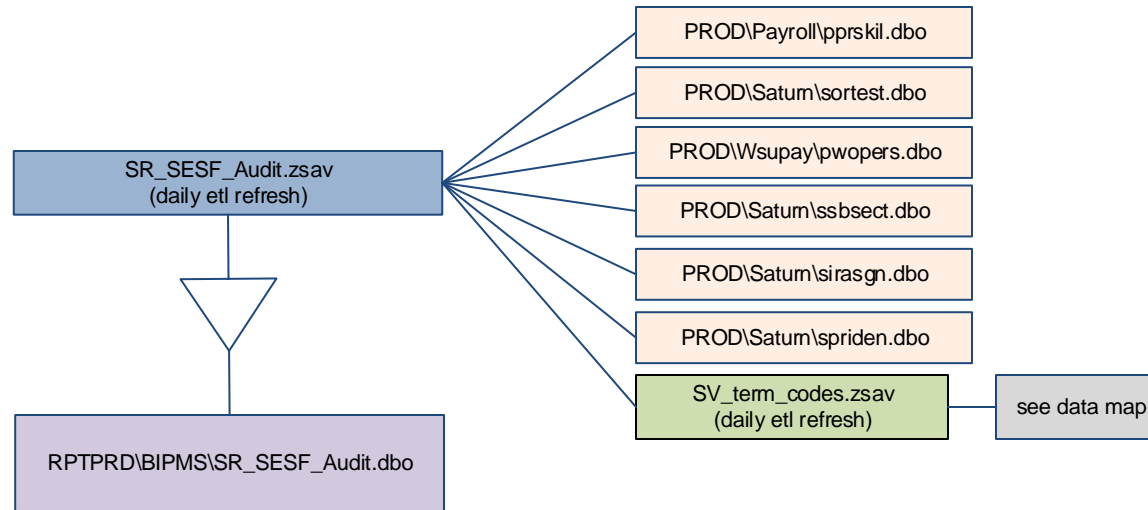

Notes: refresh daily am.  
Audits compliance with the Spoken English Screening Form (SESF) for all personnel connected to instructional duties.  
RPTPRD indexes on TERM  
Revised 01/28/2015.

# SS\_adm\_MFR [Supplemental] Admissions MFR Scores and Rankings (Incoming)

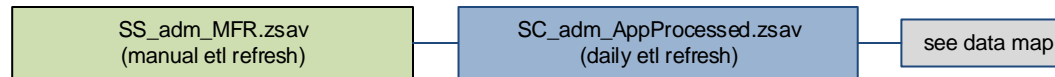

Notes: Manual etl refresh.  
Creates RFM analysis output for scoring and ranking applicants (banner) for HS, College and zipcode locations, feeds SORTTEST on PROD and SU\_adm\_Scores.sav

Revised 08/15/2013

# SS\_adm\_PreCollegeCurr [Supplemental] Admissions Pre-College Curriculum (Incoming)

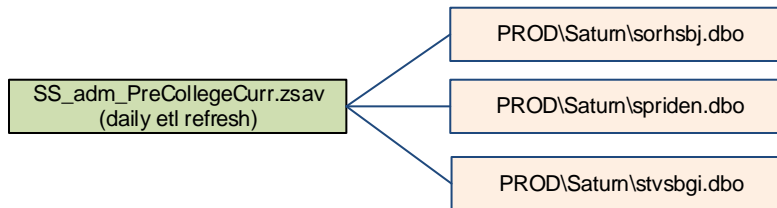

Notes: Refresh daily am  
Pre college curriculum table that has been reduced to a single record of pidm by HS school with slotted pre college curriculum, supplemental table for joins to admission applications & recruits.  
Revised 08/15/2013



# SS\_Adm\_RoyallSelfRep\_Scores [Supplemental] Admissions Royall Based Self Reported Scores (Incoming)



Notes: Refresh daily am  
Self reported scores from admission student passed through Royall online application.  
Revised 01/27/2015

# SS\_Adm\_UD\_CallerLog [Supplemental]

## Contact Activity of UD Callers

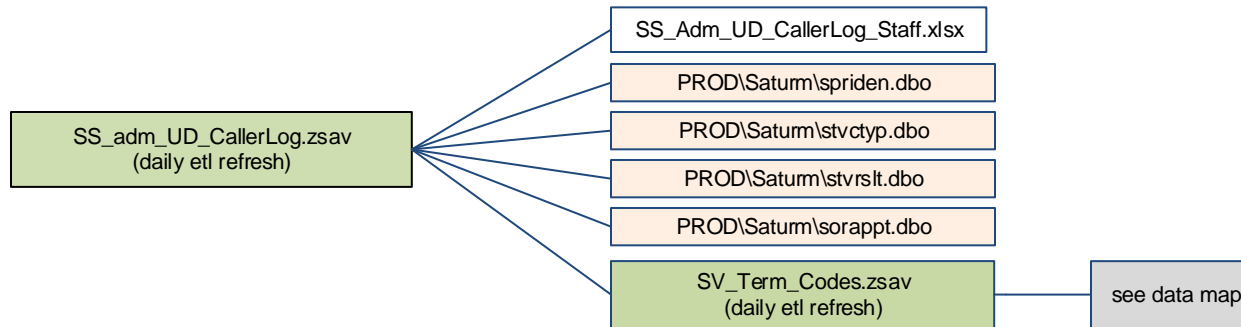

Notes: refresh daily am  
Undergraduate Admission Call Log activity.

Revised 01/27/2015

# SS\_adm\_UGnewStuORT [Supplemental] New Student Summer Orientation

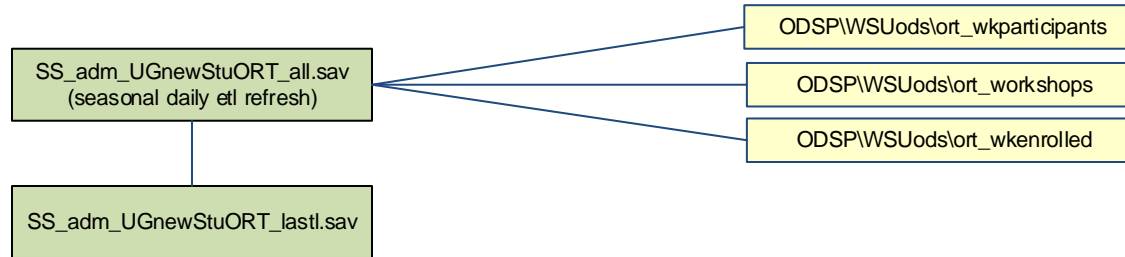

Notes: Refreshed daily am during term registration until 20thday.  
Pulls data from the new student summer orientation program.  
Revised 01/27/2015.

# SS\_AFD\_AlumniSurvey [Supplemental] Alumni Survey post AFD Graduation

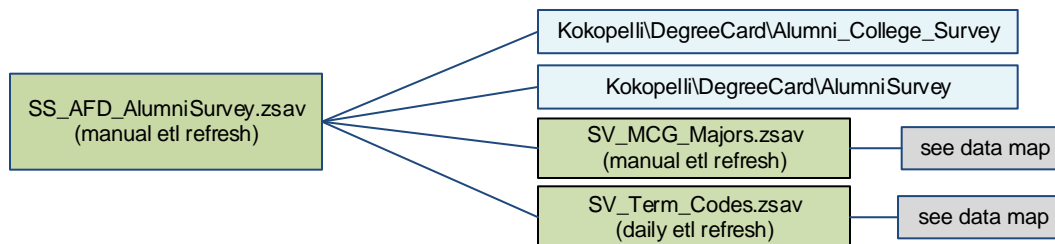

Notes: Refreshed manually.  
Six months post graduation AFD participants are sent an alumni survey.  
Revised 08/15/2013.

# SS\_AFD\_ExitSurvey [Supplemental] UG & GR Exit Surveys

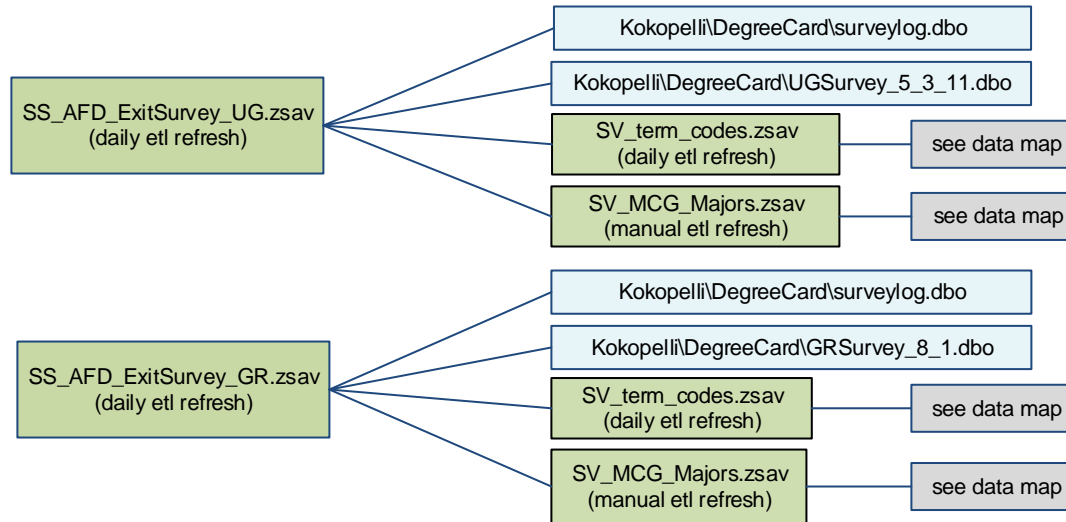

Notes: refresh daily am.  
UG & GR Exit Surveys for AFD submitters  
Revised 08/15/2013.

# SS\_enrlhist & SS\_enrlhist\_1stTerm [Supplemental] Enrollment Activity by Term and 1<sup>st</sup> UG and GR Enrolled Term

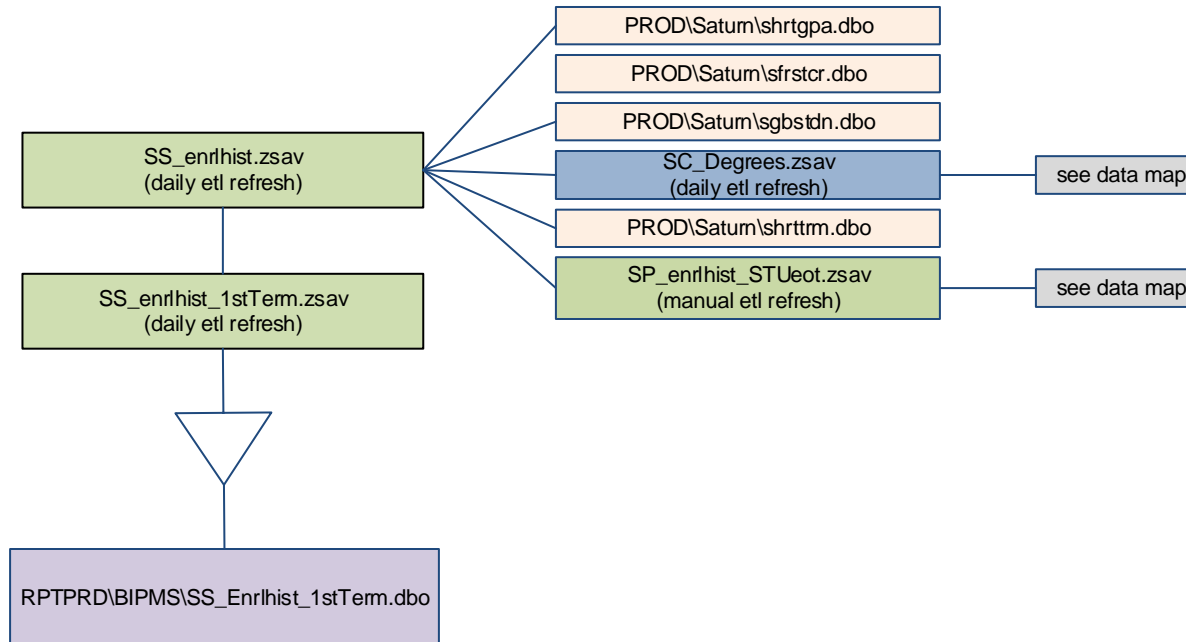

Notes: refresh daily am  
 Provides enrollment history and future registered terms. SHRTGPA term take precedence, if null stueot is filled & for future registered terms sfbetm fills. Major code is corrected for end of term major code from stu\_eot table when available. In addition, SS\_enrlhist\_1stTerm provides the 1<sup>st</sup> UG and 1<sup>ST</sup> GR term for student.  
 RPTPRD indexes on PIDM.  
 Revised 01/27/2015

# SS\_Faculty\_GradFaculty\_Status [Supplemental]

## Graduate Faculty Status

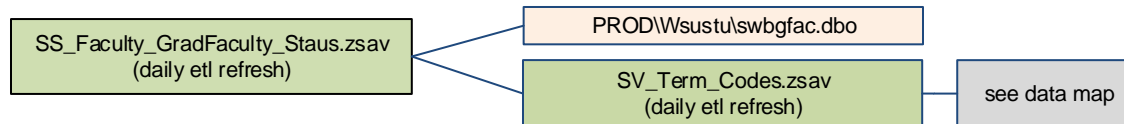

Notes: refresh daily am  
Provides latest activity for Graduate School Graduate Faculty status.

Revised 08/18/2013

# SS\_Faculty\_Sabbatical\_History [Supplemental]

## Faculty Sabbaticals

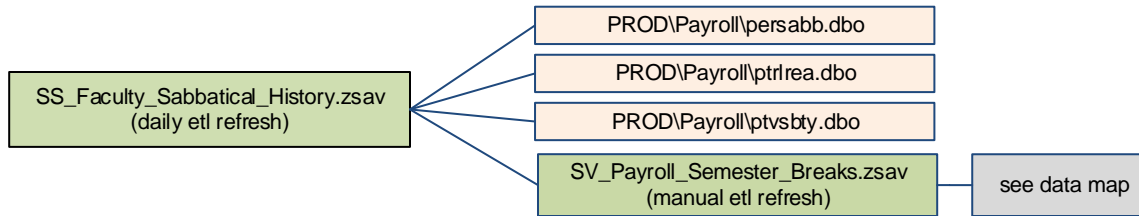

Notes: refresh daily am  
Provides the sabbatical history of faculty.

Revised 08/18/2013



# SS\_Faculty\_Staff\_Nov\_Employ [Supplemental]

## Faculty & Staff November Employment Freeze

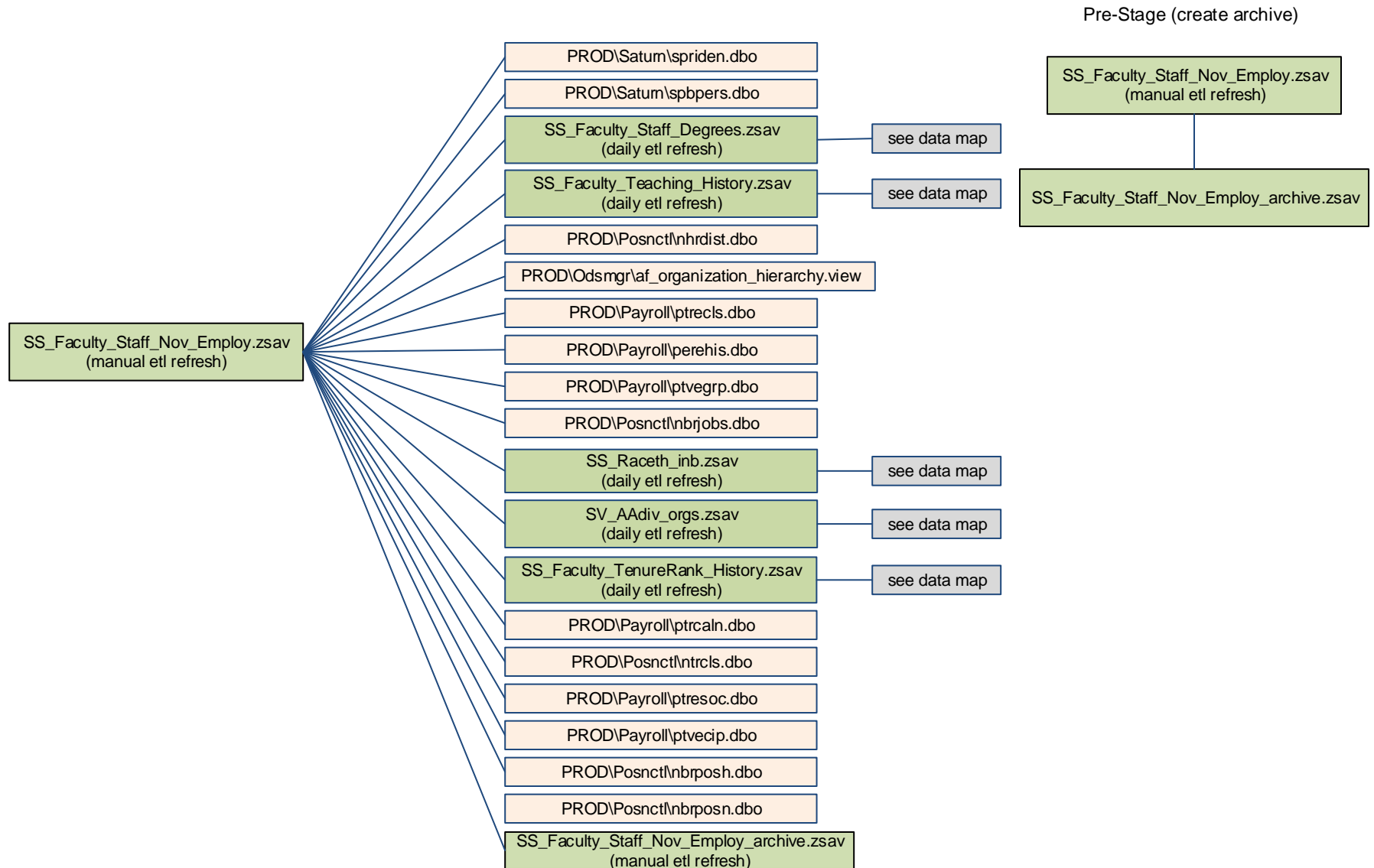

Notes: manual execution.  
Provides employee counts and fte for those employed on the 1<sup>st</sup> week of November.

# SS\_Faculty\_Staff\_Degrees [Supplemental]

## Faculty/Staff Highest Degree Attained

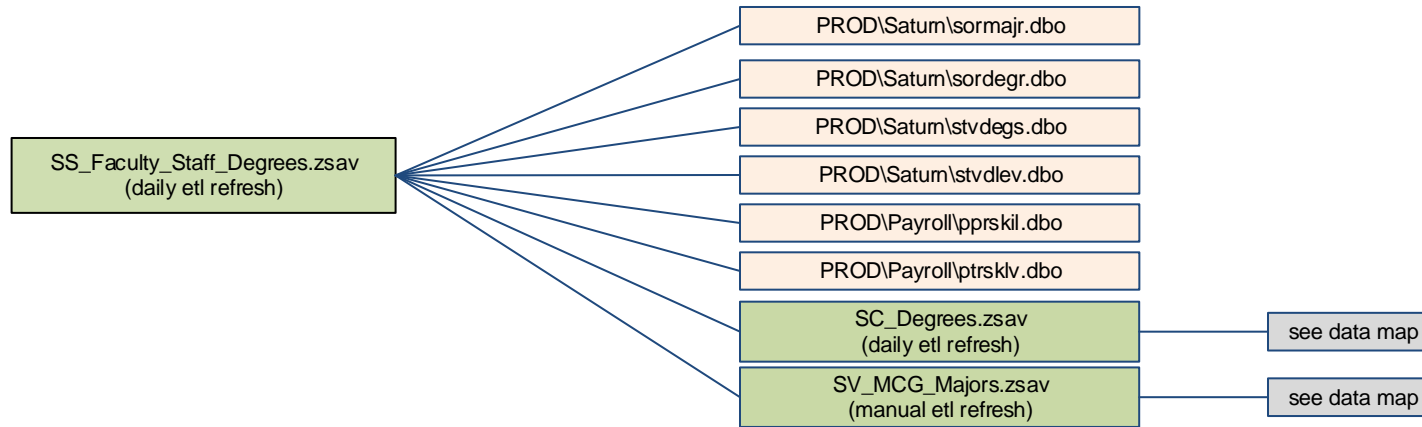

Notes: refresh daily am  
Provides the highest degree attained by faculty & staff.

Revised 04/09/2015

# SS\_Faculty\_Teaching\_History [Supplemental]

## Faculty Teaching History by term and crn

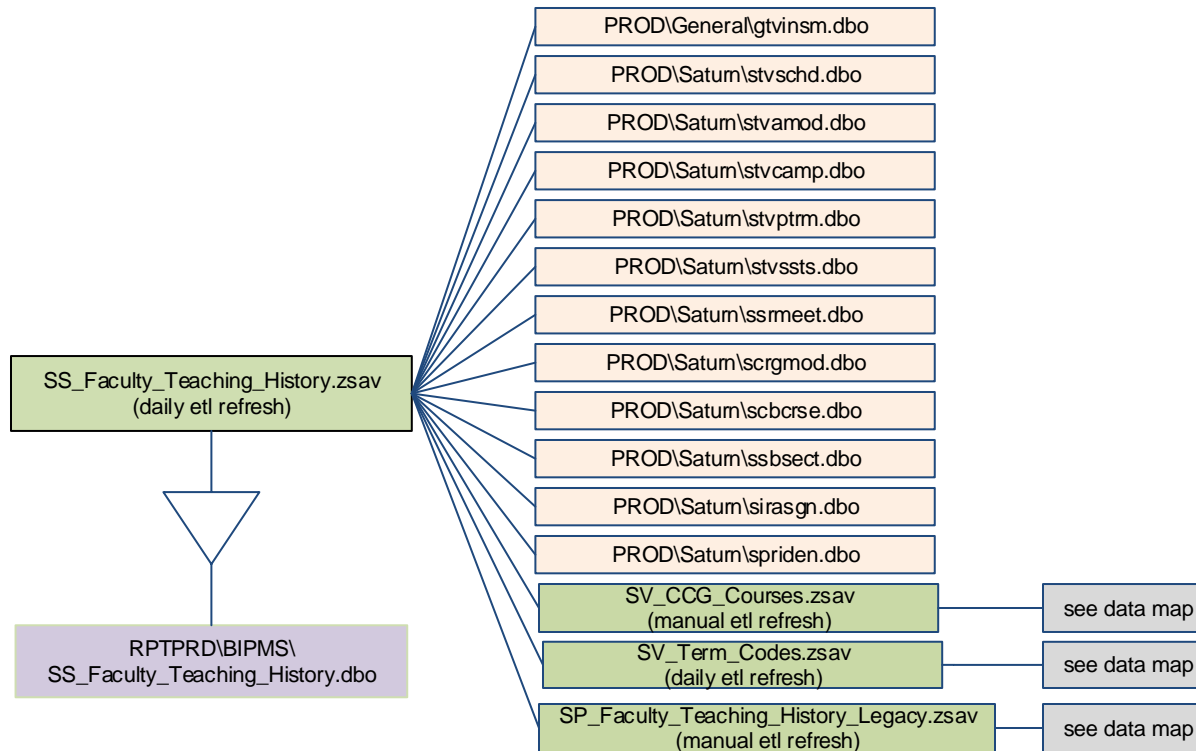

Notes: refresh daily am  
 Provides detail (term by cm) of teaching activity for teaching faculty.  
 RPTPRD indexes on PIDM & TERM

Revised 08/18/2013

# SS\_Faculty\_TenureRank\_History [Supplemental]

## Faculty History of Tenure and Rank

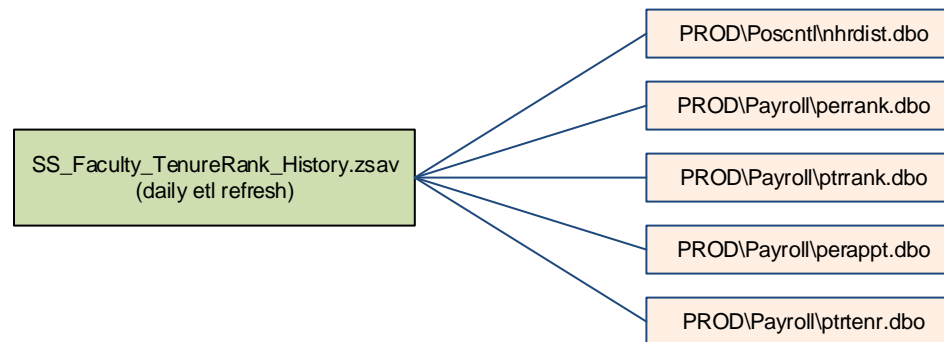

Notes: refresh daily am  
Provides the tenure and rank history by term for faculty

Revised 01/26/2015

# SS\_Faculty\_TenureRank\_Latest [Supplemental]

## Faculty Tenure and Rank Status Latest Activity

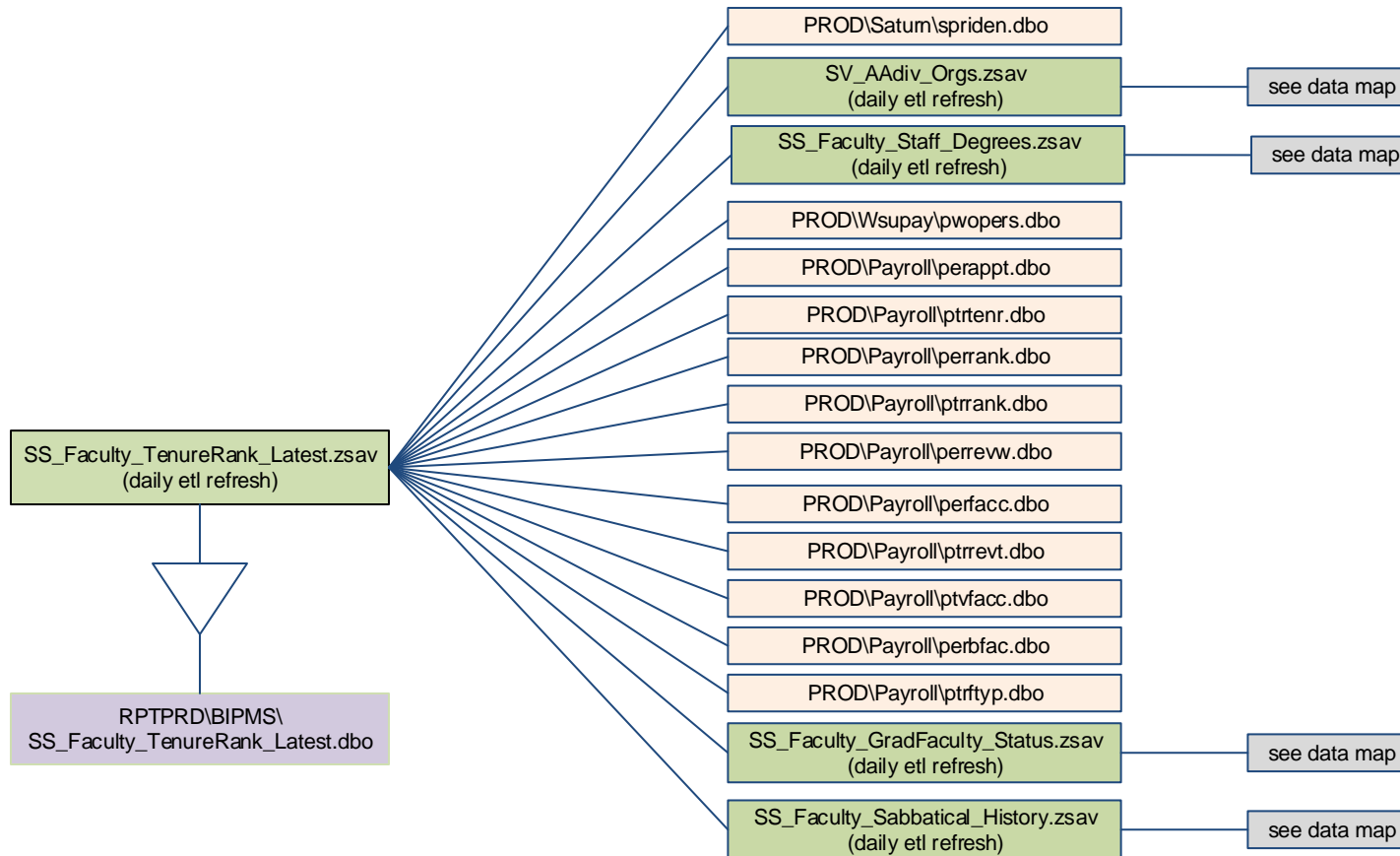

Notes: refresh daily am  
Provides the latest (including non active employees) tenure and rank status of faculty.  
RPTPRD indexes on PIDM.

Revised 04/09/2015

# SS\_Finaid [Supplemental] Financial Aid

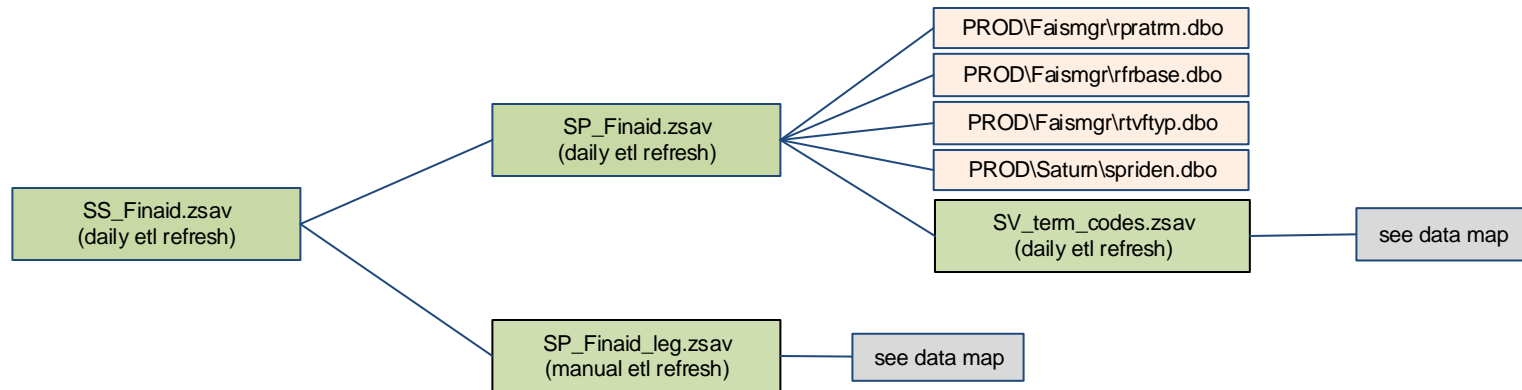

Notes: Refresh daily am.  
Legacy and Banner Financial aid data for supplemental joins to BIPMS cores.  
Revised 01/26/2015.

# SS\_Finaid\_FAS [Supplemental] Financial Aid Standing

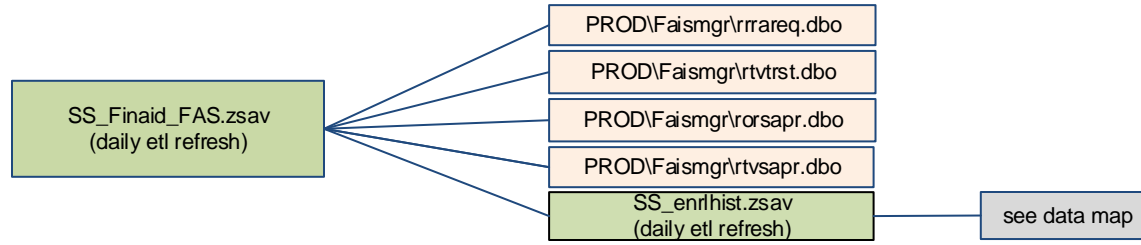

Notes: Refresh daily am.

Student financial aid standing status.

Revised 08/15/2013.

# SS\_Finaid\_Low\_Income [Supplemental] Low income ranges

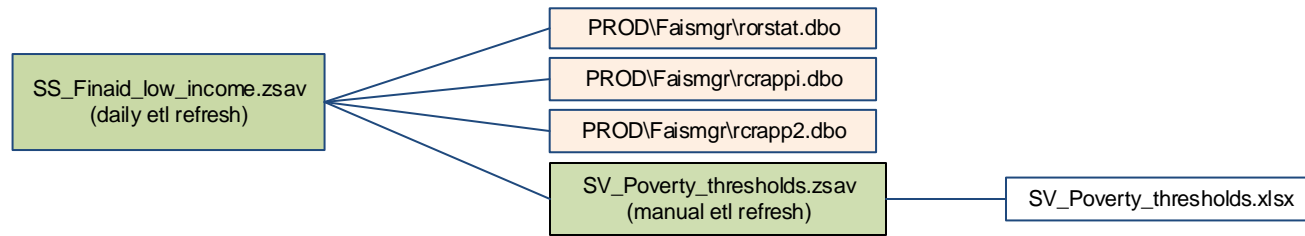

Notes: Refresh daily am.  
Provides poverty, 125% of poverty and 150% of poverty indicators.  
Revised 01/26/2015.



# SS\_GradAppts [Supplemental] Graduate Student Appointments

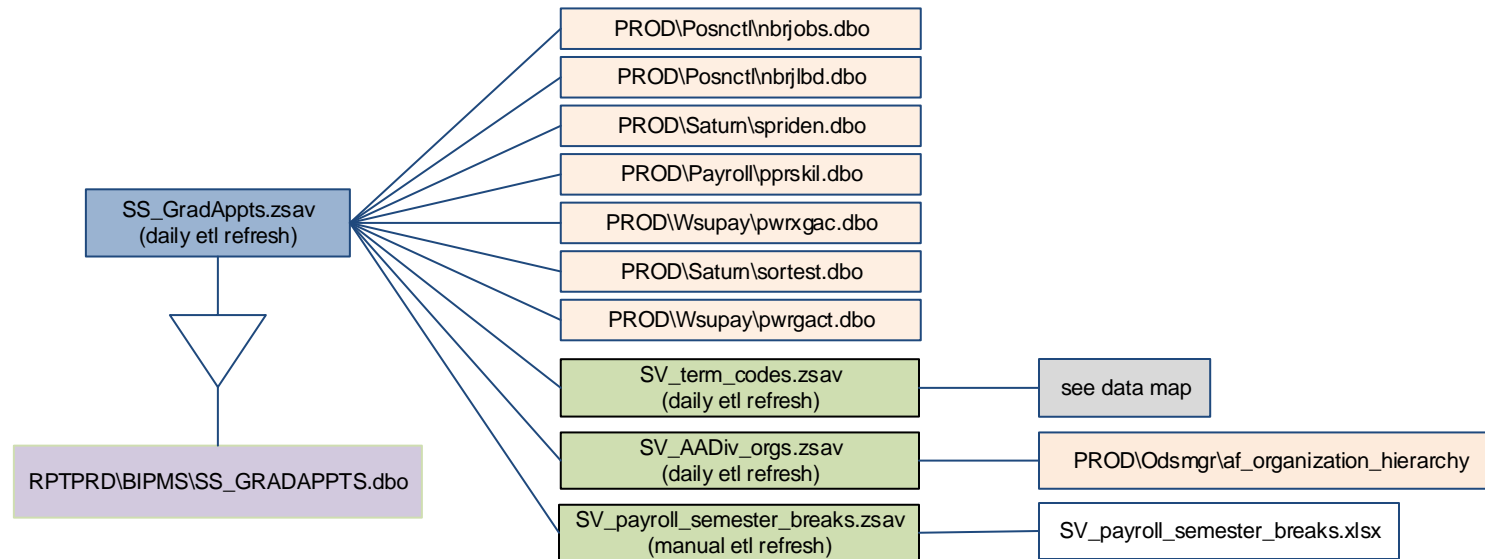

Notes: Daily refresh am.  
 Graduate student appointment database, data entry from PWAGACT custom Banner form.  
 RPTPRD indexes on PIDM & GA\_TERM.  
 Revised 01/26/2015.

# SS\_Housing [Supplemental] Student Housing Occupancy

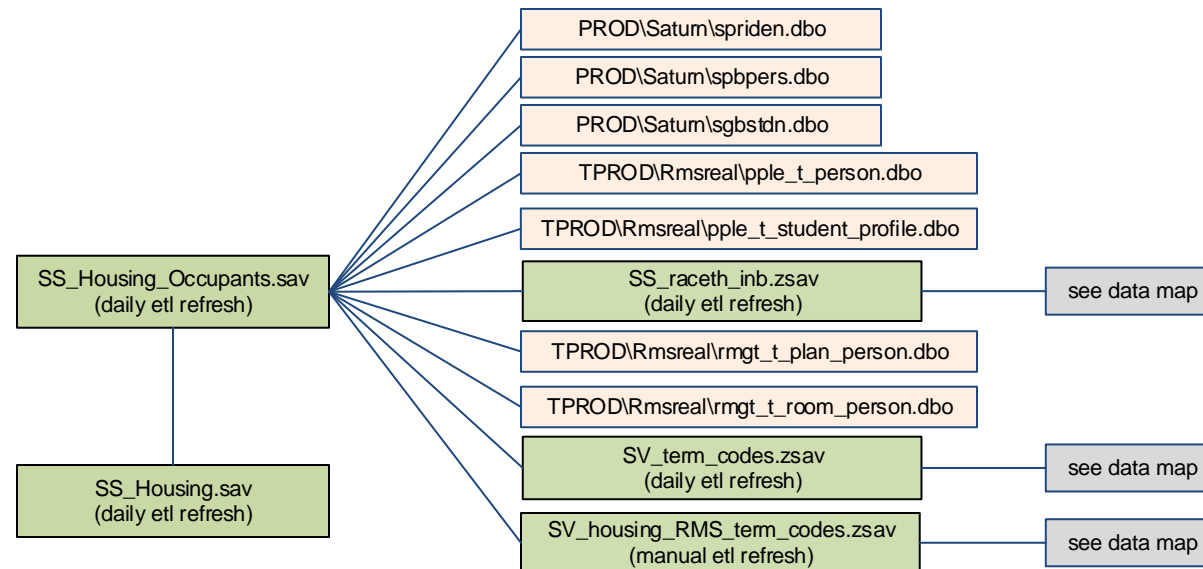

Notes: Refreshed daily am.  
 Provides data on student housing as a supplemental join to BIPM cores, only banner data available.  
 SS\_Housing\_Occupants includes all RMS occupancy records; SS\_Housing includes only those with valid pidm records.  
 Revised 01/26/2015.

# SS\_Housing\_Applications [Supplemental] Student Housing Applications

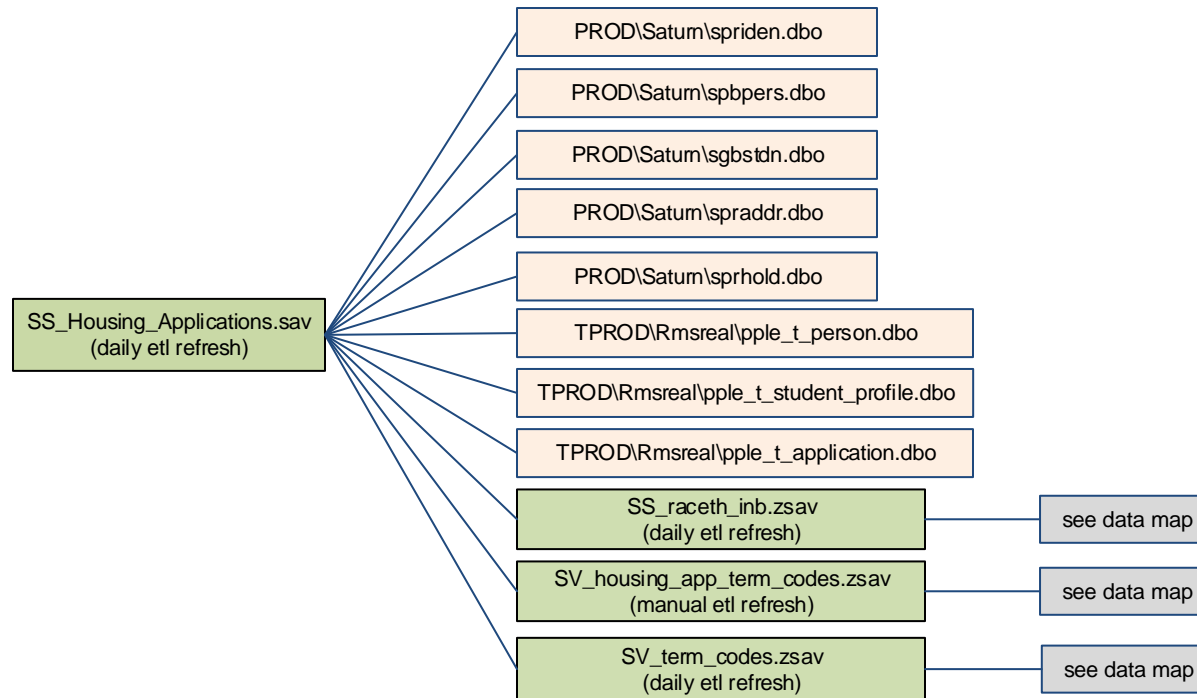

Notes: Refreshed daily am.

Provides data on student housing applications.

Revised 01/26/2015.

# SS\_KBOR\_UGadvSurvey [Reporting] KBOR student advising survey

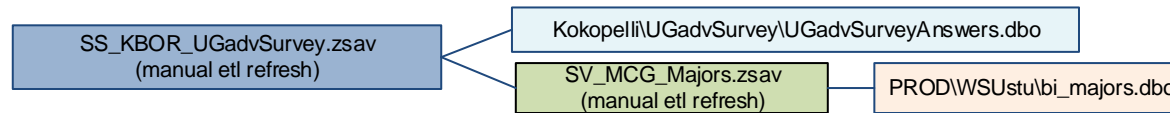

Notes: Manual.  
KBOR required yearly survey of students regarding their advising experiences.  
Revised 08/13/2013.

# SS\_Payroll [Supplemental] Student Payroll

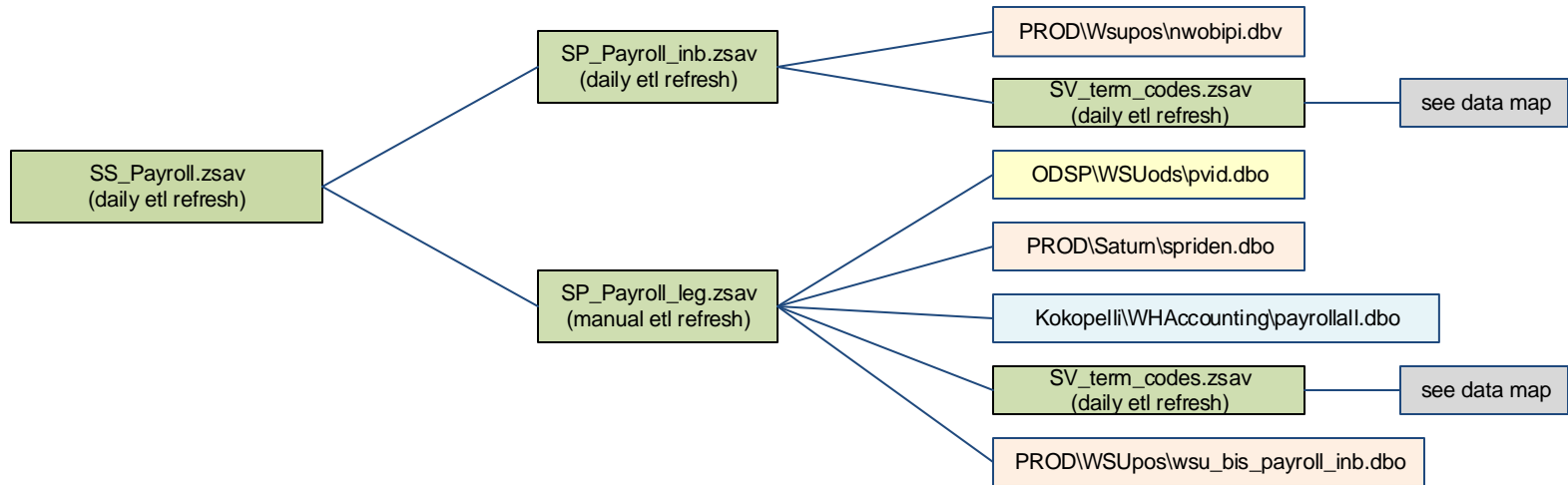

Notes: Refreshed daily am.  
Legacy and Banner student (UG & GR) payroll data for supplemental joins to BIPM cores. SP\_Payroll\_inb is ran as embedded code in SS\_Payroll.  
Revised 08/15/2013.

# SS\_prevINST [Supplemental] Previous Institutions Attended

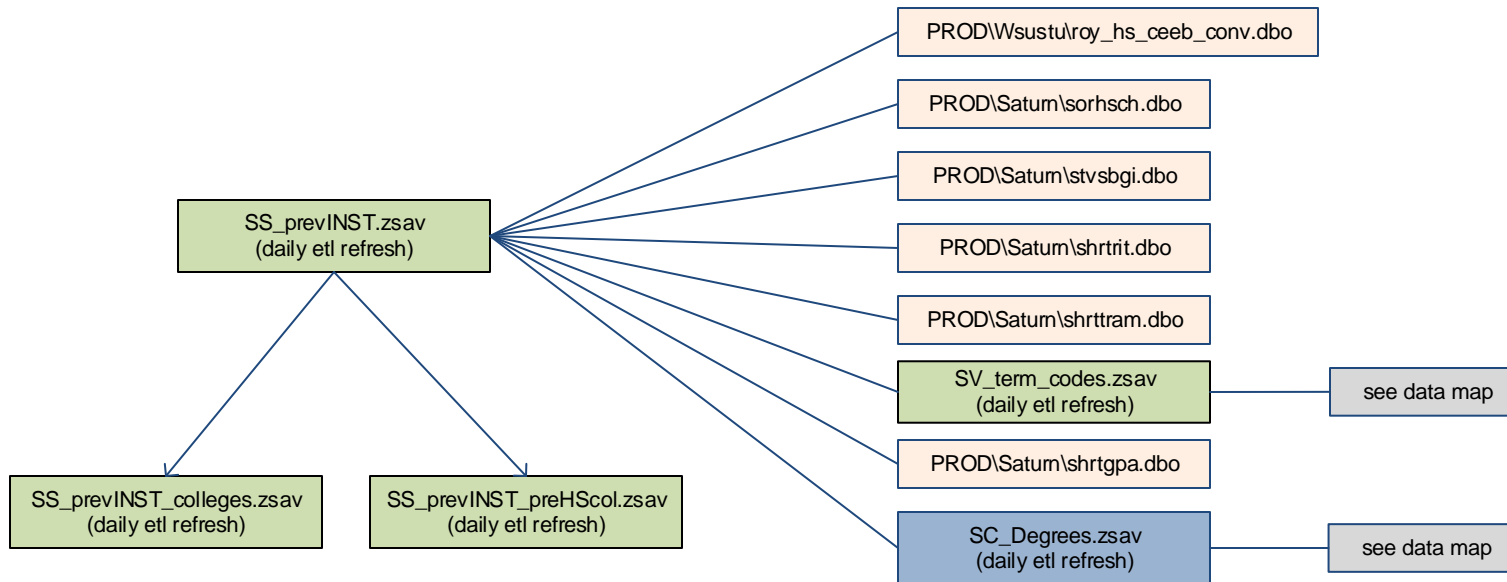

Notes:  
Refreshed daily am. Provides supplemental data to BIPMS cores to display previous educational institutions (HS & colleges).  
Revised 01/23/2015.

# SS\_PWOPERS [Supplemental] BIPM PWOPERS Version

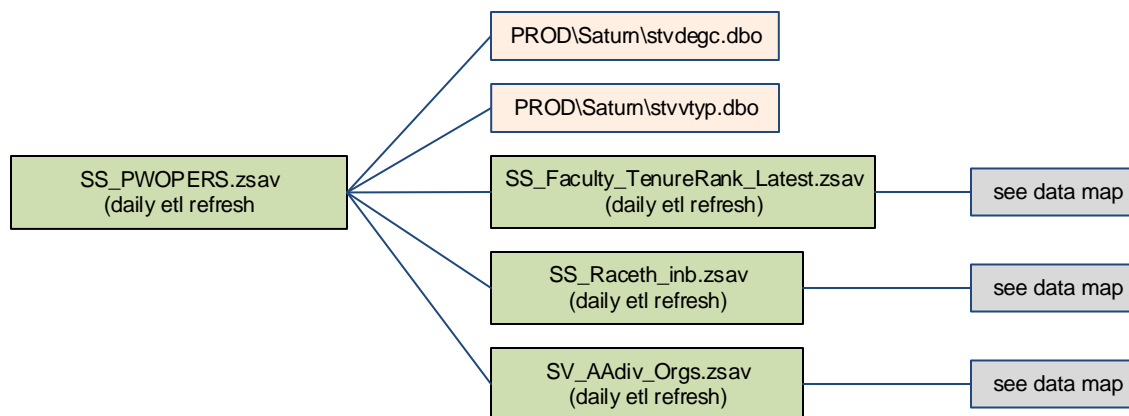

Notes: Daily refresh am.  
Provides supplemental data to BIPM cores, includes race and ethnicity values (race recode of foreign students must still be applied upon BIPM joins)  
Revised 01/23/2015.

# SS\_Raceth\_inb [Supplemental] Banner-based Race/Ethnicity (Raceth)

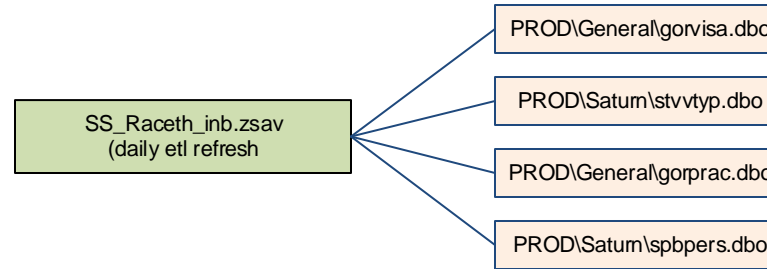

Notes: Daily refresh am.

Provides supplemental data to BIPM cores, includes race and ethnicity values (race recode of foreign students must still be applied upon BIPM joins)

Revised 08/15/2013.



# SS\_SARD [Supplemental] Student Accounts Receivables Database SARD

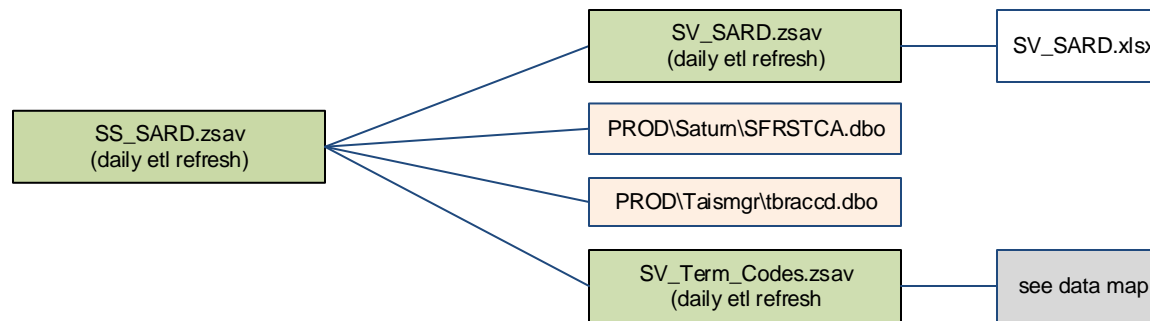

Notes: Refreshed daily am (job executes SV\_SARD before processing SS\_SARD main code)

Student accounts receivable data built from TBRACCD, used as supplemental for joins with BIPM cores.

Revised 08/15/2013.

# SS\_SEAS & SS\_SEAS\_LAST [Supplemental] Student Early Alert System

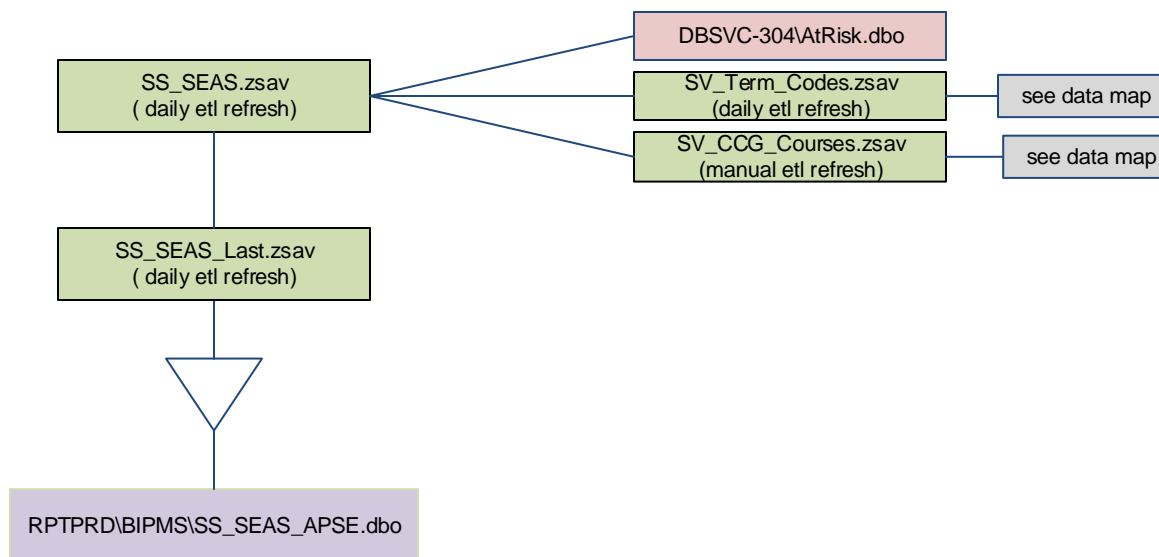

Notes: Daily refresh am.  
Provides student learner attributes repeating per term.  
RPTPRD indexes on PIDM, SEAS\_TERM CRS\_CRN.  
Revised 01/23/2015

# SS\_SGRSATT [Supplemental] Student Learner Attributes

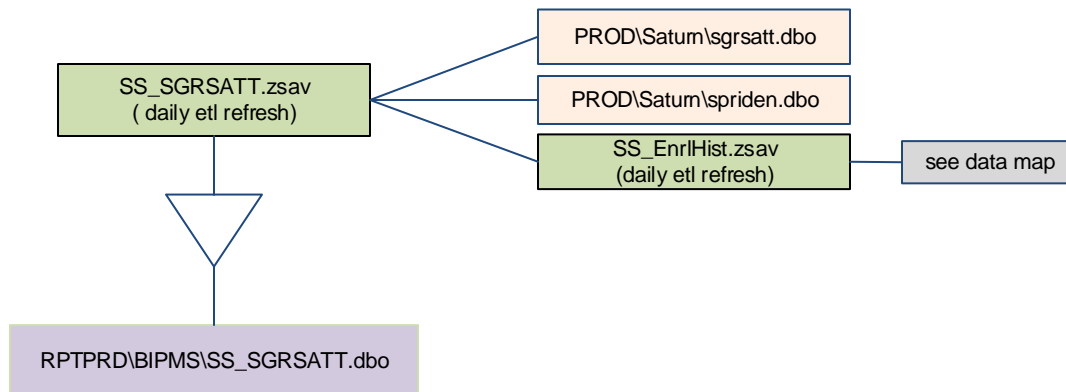

Notes: Daily refresh am.  
Provides student learner attributes repeating per term.  
RPTPRD indexes on PIDM and TERM.  
Revised 08/15/2013

# SS\_SSC\_DegreeRisk [Supplemental]

## EAB SSC Degree Risk Scores



Notes: refresh daily am  
Education Advisory Board EAB Student Success Collaborative SSC degree risk scoring.

Revised 01/27/2015

# SS\_STUhist\_demo [Supplemental] Student Demographics

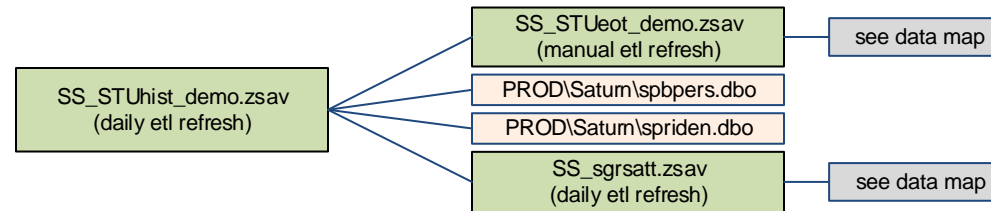

Notes: Daily refresh am.

Provides data to BIPM builds for current demographics (birthdate and sex) and first generation indicator.

Revised 08/15/2013

# SU\_adm\_Scores [Other – upload] Recruit and Application Scores for Sortest Upload (Incoming)

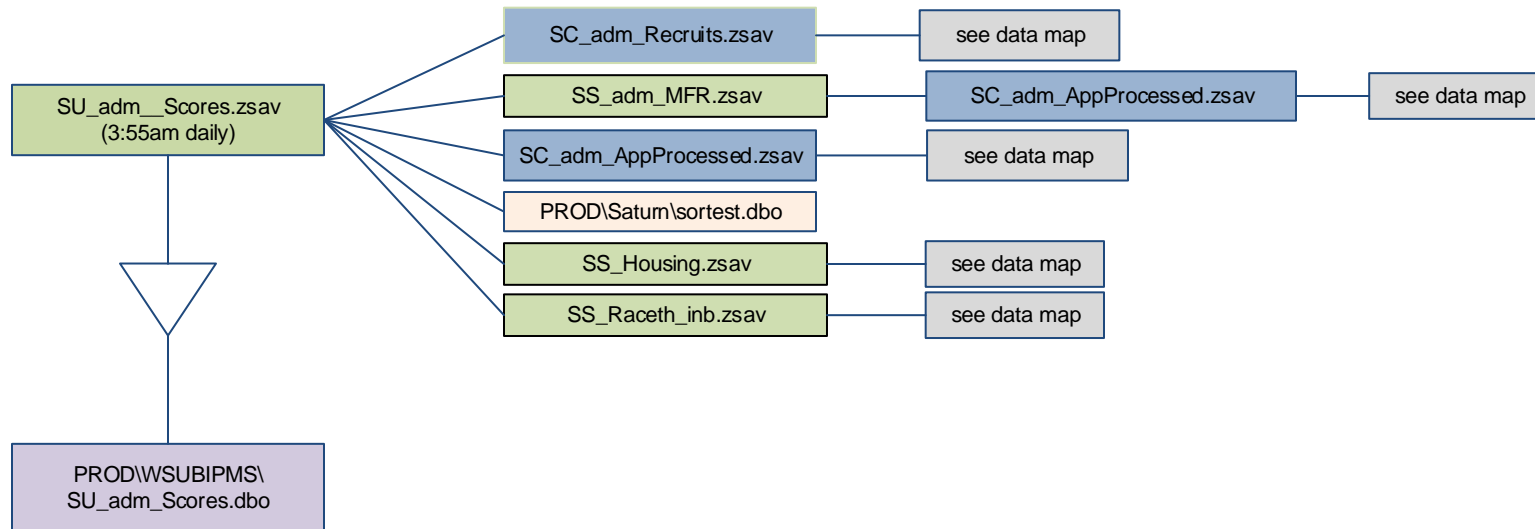

Notes: Refreshed daily at 3:55am.  
Provides academic and recruiting scores for UG students (banner only), feeds BIS01000 Student At Risk reports and BIPM cores.  
Revised 08/02/2013.

# SU\_adm\_Scores\_wterms [Other – upload] Admission Scores for Sortest Upload (Incoming)

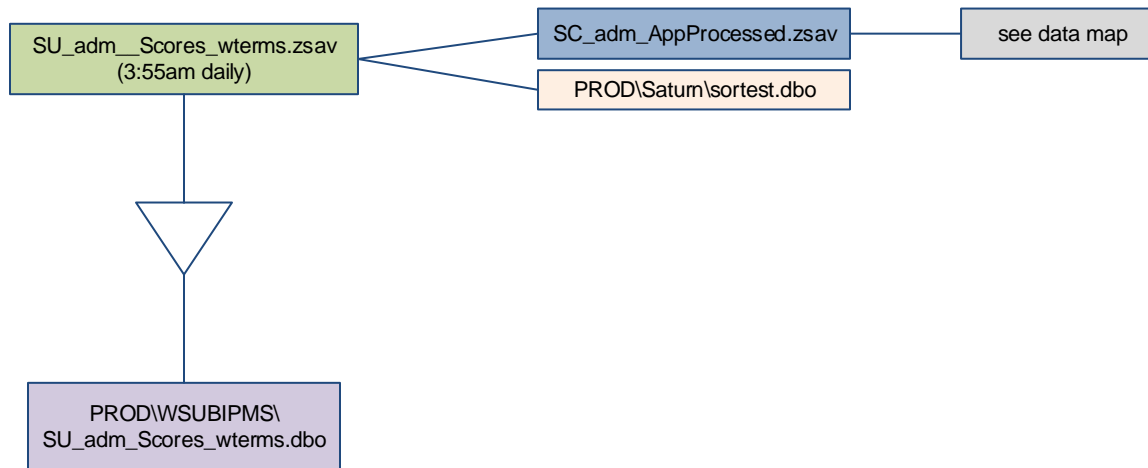

Notes: Refreshed daily at 3:55am.  
Provides admission scores for for upload to RPTD to upload into Banner Sortest.  
Revised 09/09/2013.

# SU\_ColBus\_scores [Other – upload] College of Business GMAT & Watson/Glaser Sortest Upload

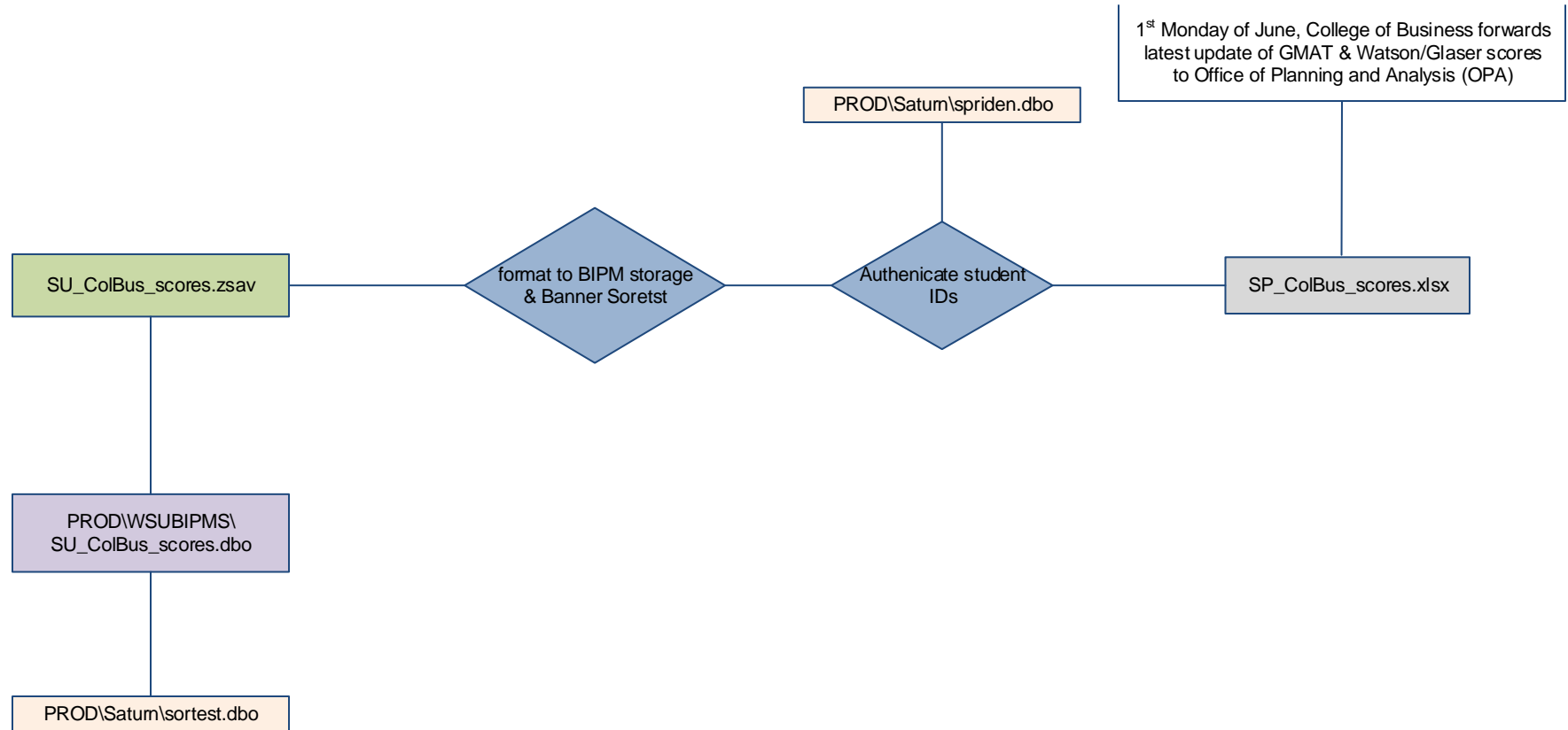

Notes: Refreshed manually.

Provides GMAT and Watson/Glaser scores from College of Business including upload of scores to Banner Sortest table.

Revised 08/13/2013.



# SV\_AAdiv\_orgs [Validation] Banner Organization Codes Converted to AAR & Non-AAR units

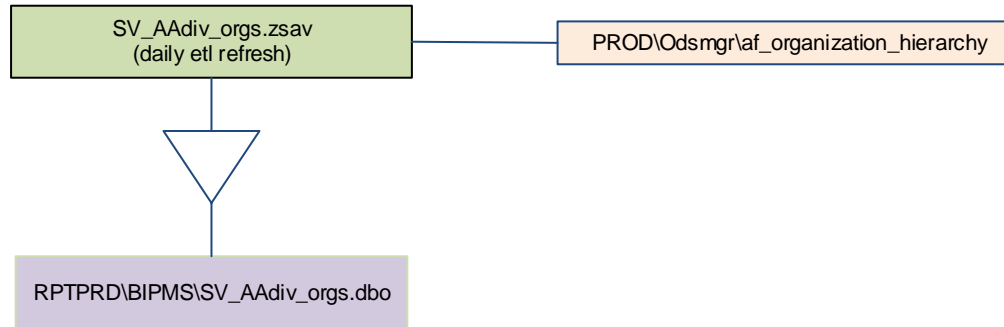

Notes: Refreshes daily am.  
Converts Banner organization codes into AA and Non-AA units (ala MCG\_DIV).  
RPTPRD index on ORGA.

Revised 01/23/2015

# SV\_adm\_AppFreeze\_weeknum [Validation] Admissions Applications Freeze Dates (Incoming)

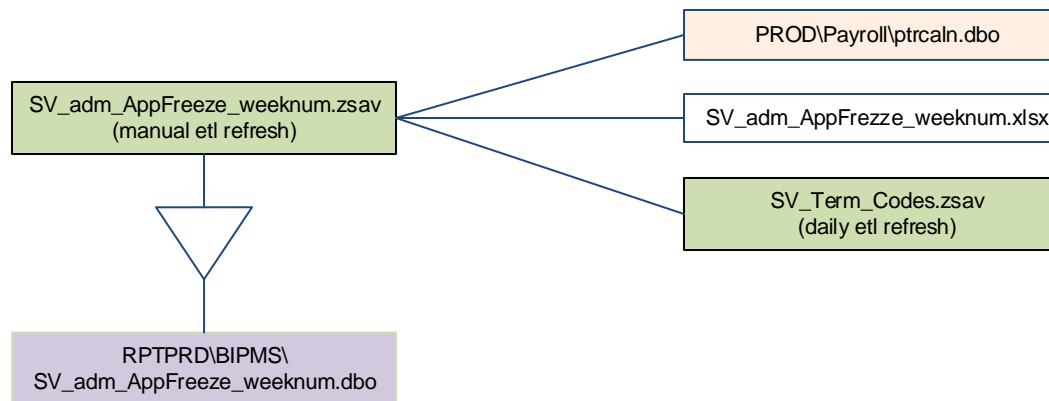

**Notes:**

Provides ISO calendar week count and dates including associated banner term values for the weekly admission application Monday freeze, feeds SP\_adm\_AppFreeze.sav.  
RPTPRD index on FREEZE\_DATE.

Revised 01/12/2015

# SV\_Adm\_Decision\_STVAPDC [Validation] Admissions Decision Code Groupings (Incoming)

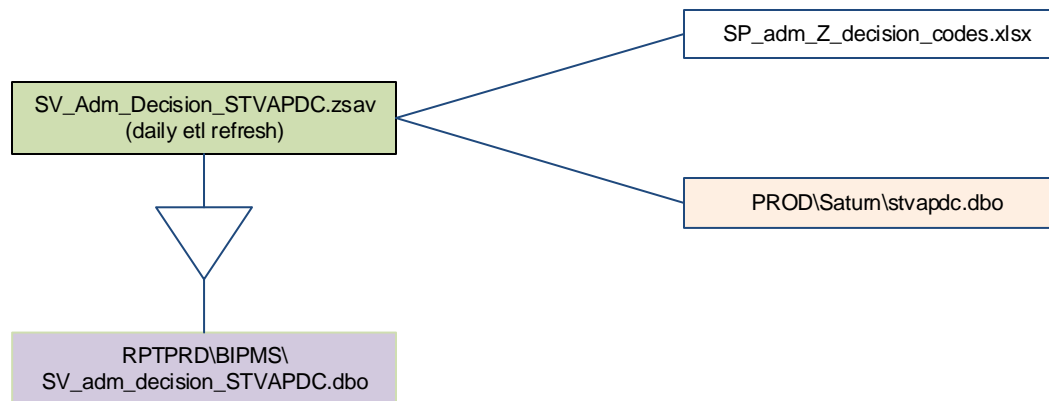

Notes:  
Provides categories for reporting admission decision codes.  
RPTPRD index on STVAPDC\_CODE.  
Revised 01/14/2015

# SV\_CCG\_Course [Validation] Course Code Group CCG

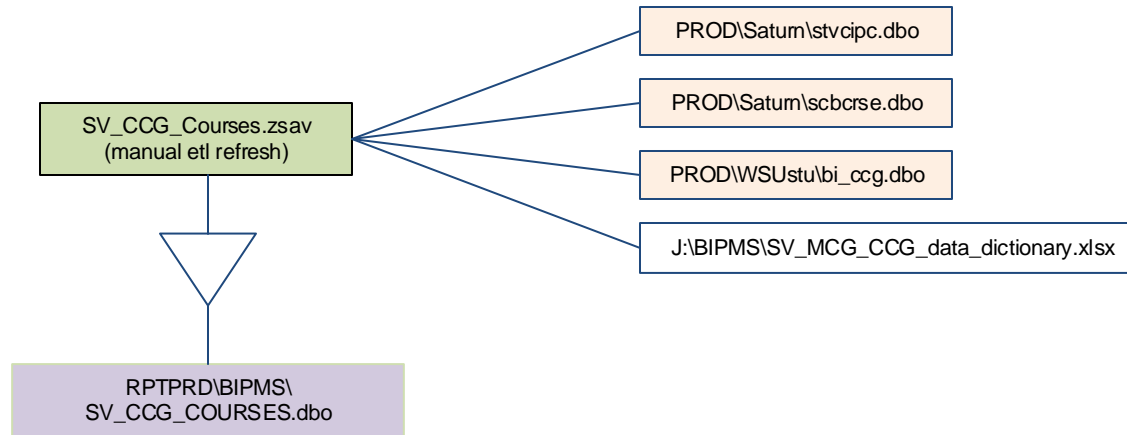

Notes: Manually updated whenever a new course (subj\_code) is created.  
Applies the Course Code Group logic to the course subject code to place courses within their current institutional structures.  
RPTPRD index on CRS\_SUBJ.  
Revised 01/12/2015.

# SV\_CEEB\_Codes\_HS & SV\_CEEB\_codes\_Col [Validation] CEEB Codes for High Schools & College (Incoming)

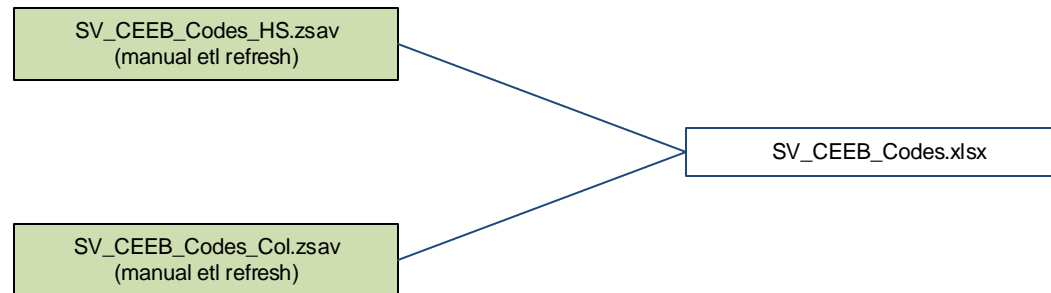

Notes:  
CEEB codes for HS & Colleges

Revised 01/14/2015

# SV\_CIP\_Codes [Validation]

## Federal CIP Codes

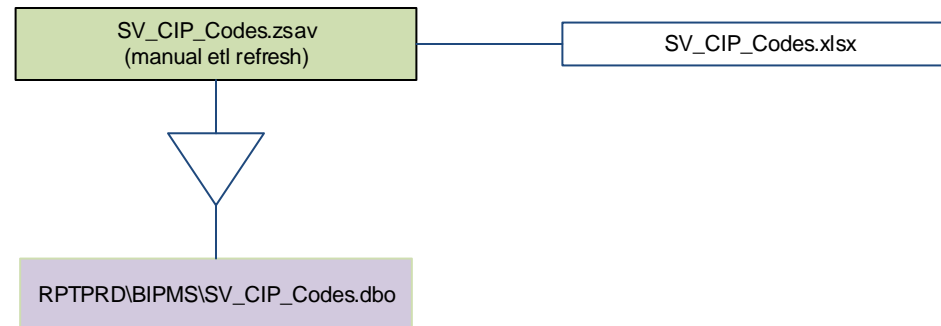

Notes:  
2010 Federal CIP codes.  
RPTPRD index on CIPNCODE.

Revised 08/13/2013

# SV\_CPI\_Income\_Deflator [Validation]

## CPI Index for Deflating Dollars

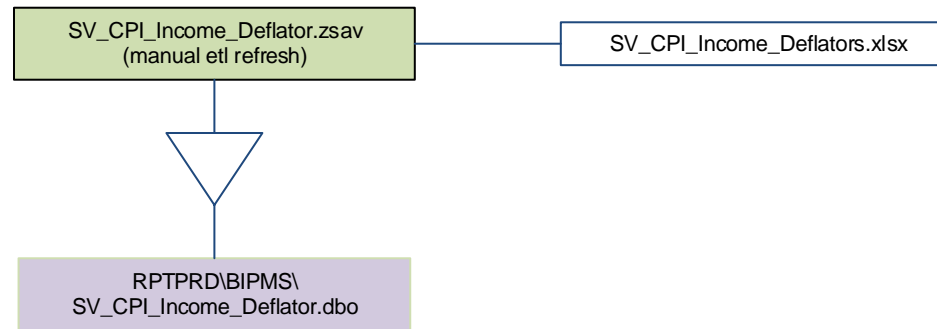

**Notes:**

Current Price Index (CPI-U) for adjusting income values over time for inflation.  
RPTPRD index on CPI\_YR.

Revised 01/16/2015

# SV\_Date\_Codes [Validation] Date Codes Historic & Future (Incoming)

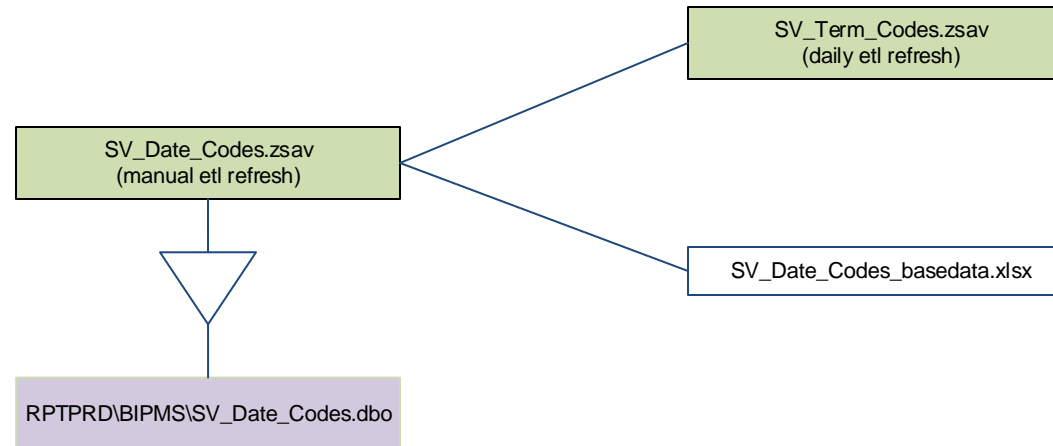

Notes:  
Date codes from 1900 to 2050 including week, month & year dimensions.  
RPTPRD index on SV\_DATENUM.

Revised 01/14/2015



# SV\_Global\_STVNATN [Validation]

## Country Code Crosswalk

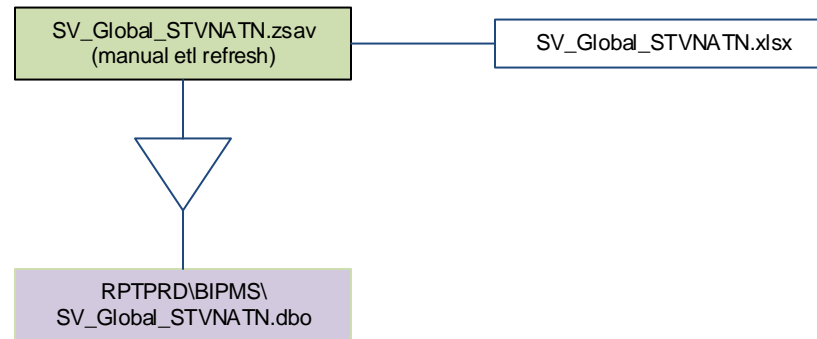

Notes:  
Country codes crosswalk.  
RPTPRD index on STVNATN\_CODE.

Revised 01/14/2015

# SV\_Housing\_RMS\_Term\_Codes & SV\_Housing\_app\_Term\_Codes [Validation]

## Housing Term Codes

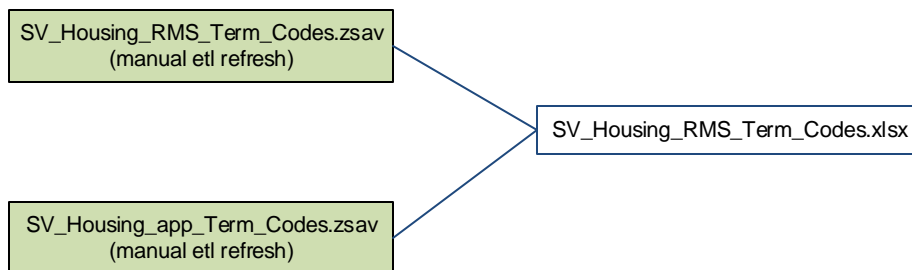

Notes:

Housing RMS term code conversions.

Revised 01/14/2015

# SV\_KS\_Counties [Validation]

## State of Kansas County Codes

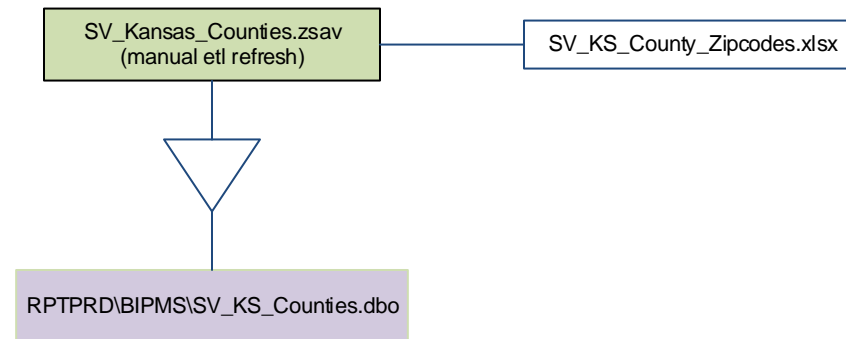

**Notes:**

County Codes and descriptions for State of Kansas.  
RPTPRD index on COUNTY.  
This table is located in the SV\_KS\_COUNTY\_ZIPCODES syntax.

Revised 01/12/2015

# SV\_KS\_County\_Zipcodes [Validation]

## State of Kansas County Zipcodes

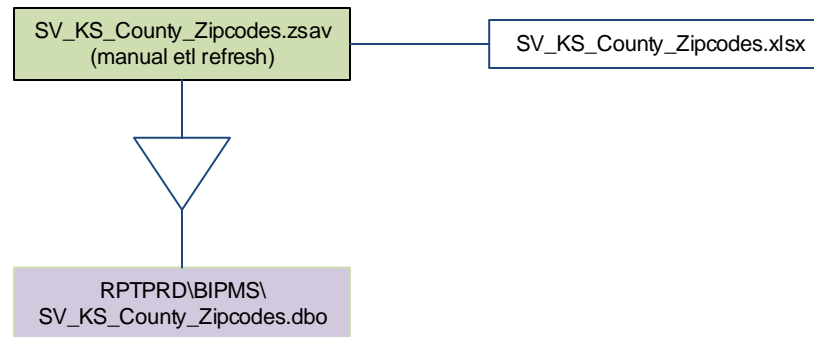

Notes:  
County ZipCodes and descriptions for State of Kansas.  
This table is located in the SV\_KS\_COUNTY\_ZIPCODES syntax.  
RPTPRD index on ZIPCODE.

Revised 01/12/2015

# SV\_leg\_inb\_HS\_crswlk & SV\_leb\_inb\_Col\_crswlk [Validation]

## Institutional (HS & College) Code Crosswalk

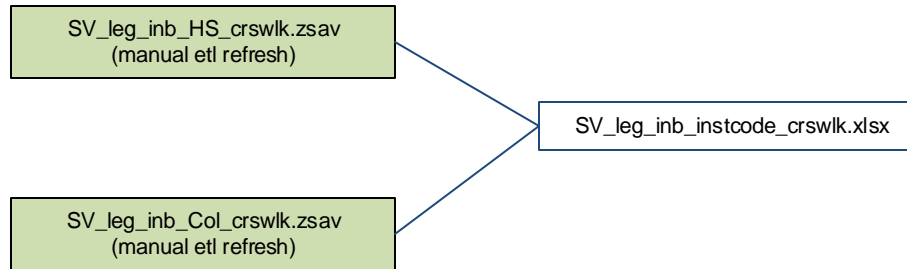

Notes:

Legacy to Banner HS & College code crosswalk.

Revised 01/14/2015

# SV\_leg\_pvid\_pidm\_ID [Validation]



Notes:  
Legacy PVID to PIDM ID crosswalk.  
Revised 01/14/2015

# SV\_MCG\_Majors [Validation] Major Code Group MCG

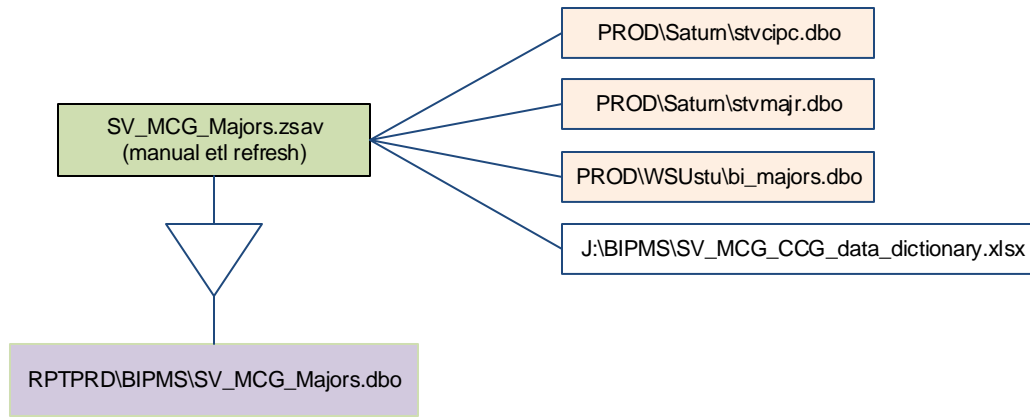

Notes: Manually ran whenever new major codes are created.  
Applies the Major Code Group logic to major codes allowing mapping of major code ownership based on current institutional structures.  
RPTPRD index on MAJOR.  
Revised 01/12/2015.

## WSU Business Intelligence and Predictive Modeling (BIPM) Major Code Group and Course Code Group Schemas

### Major Code Group (MCG)

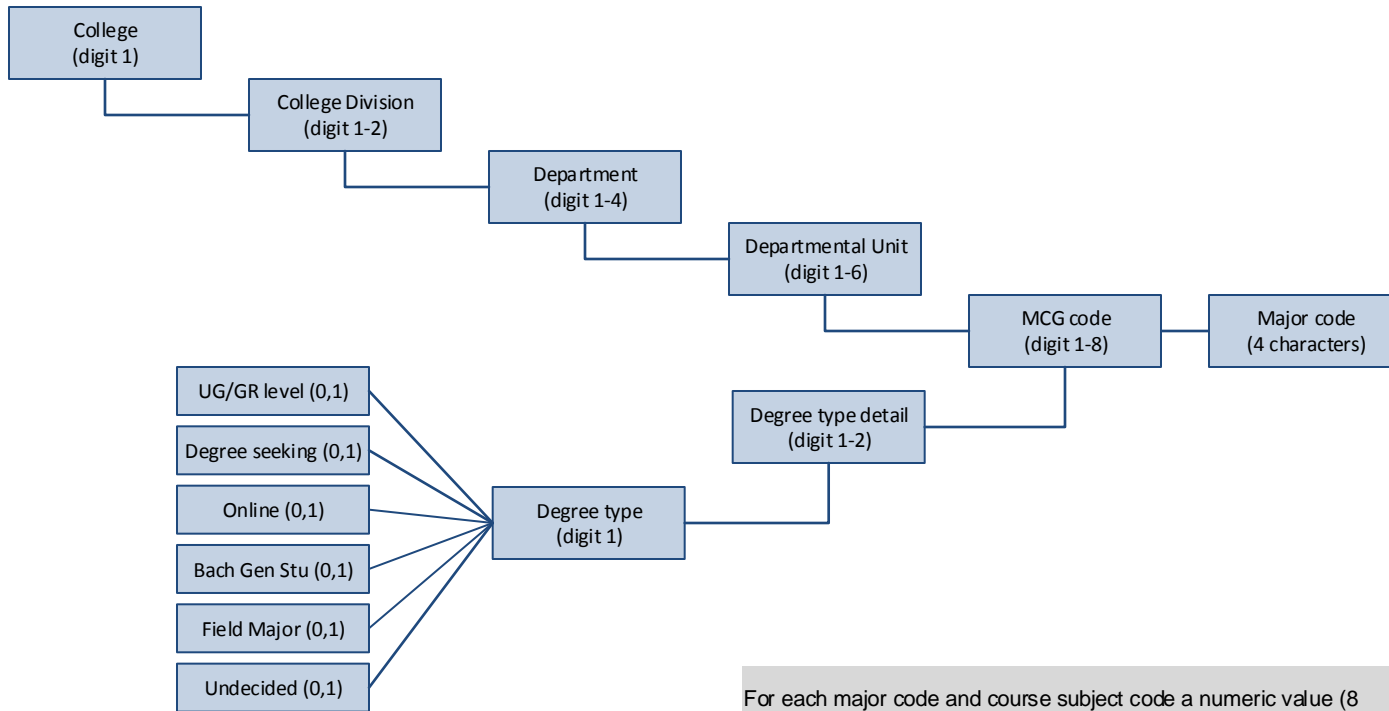

For each major code and course subject code a numeric value (8 digits for majors and 6 digit for courses) is assigned that allows for aggregation to higher dimensions for reporting and querying. In addition the MCG & CCG codes pair active and inactive code sets and can be used to report history organizationally as it is currently.

### Course Code Group (CCG)

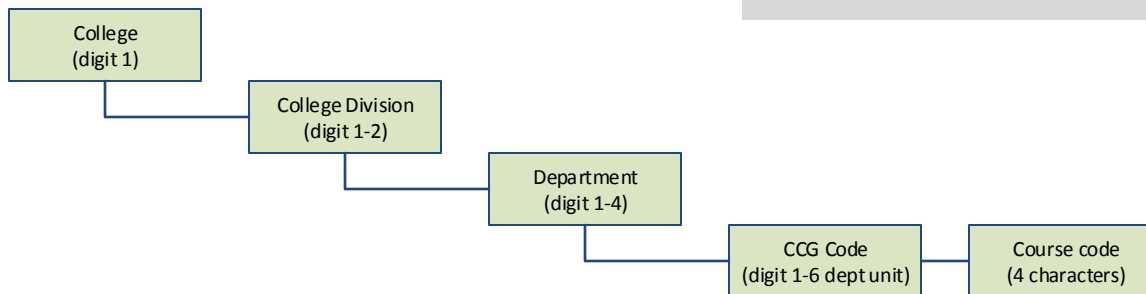



# SV\_MCG\_WSU\_ProgRev\_Codes [Validation] WSU Program Review Codes



Notes:

WSU program review codes crosswalk with MCG.

Revised 01/14/2015

# SV\_MSEP\_Majors [Validation] MSEP Major Codes

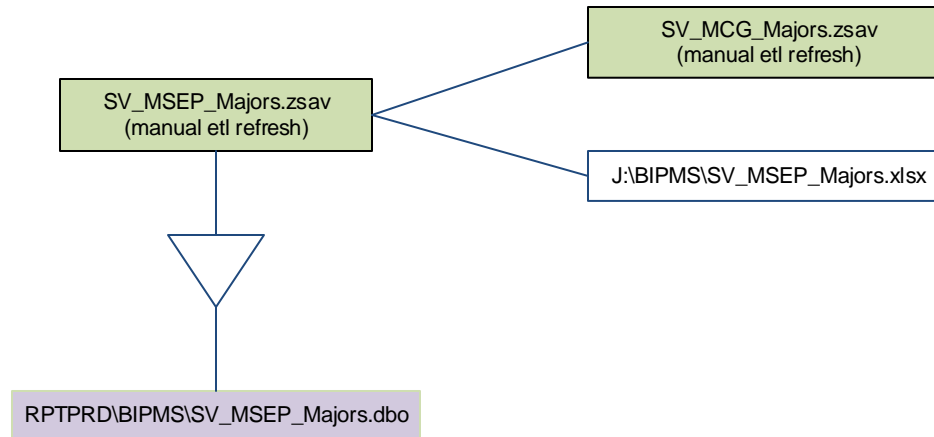

Notes: Manually ran whenever new msep major codes are created.  
RPTPRD indexes on MAJOR.  
Revised 01/12/2015.

# SV\_payroll\_semester\_breaks [Validation]

Payroll semester date term breaks

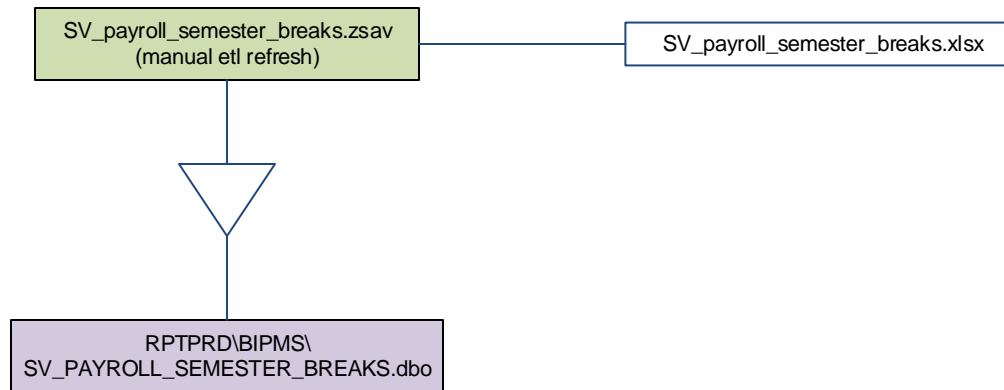

Notes:  
Payroll dates and term break points.  
RPTPRD indexes on PAY\_DATE.

Revised 01/21/2015

# SV\_Poverty\_Thresholds [Validation]

## Federal Government Poverty Thresholds

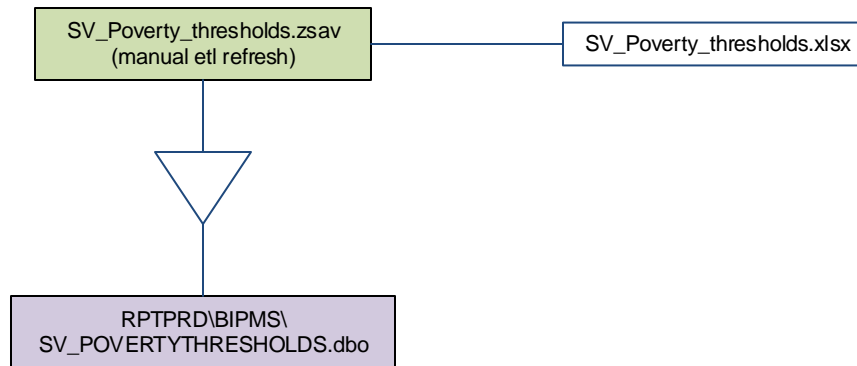

**Notes:**

Census Bureau poverty thresholds by family size  
RPTPRD indexes on TERM\_AY & FAMSIZE

Revised 01/21/2015

# SV\_SARD [Validation] Student Accounts Receivables Database

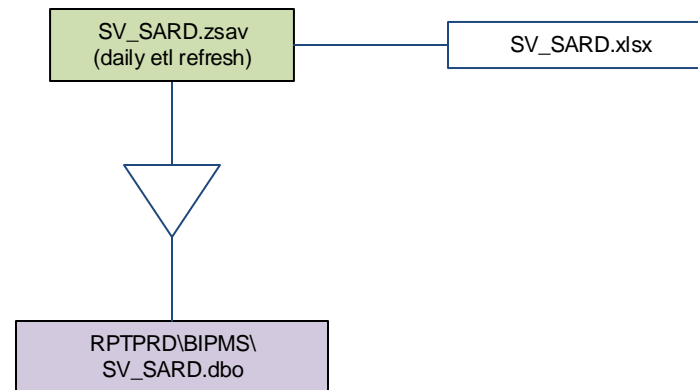

Notes: This job is executed when SS\_SARD daily etl refreshed.

Feeds SS\_SARD table. Bi-weekly new codes are loaded based on data supplied from accounts receivables.  
RPTPRD index on SARD\_CODE

Revised 08/13/2013.

# Student Accounts Receivable Database (SARD)

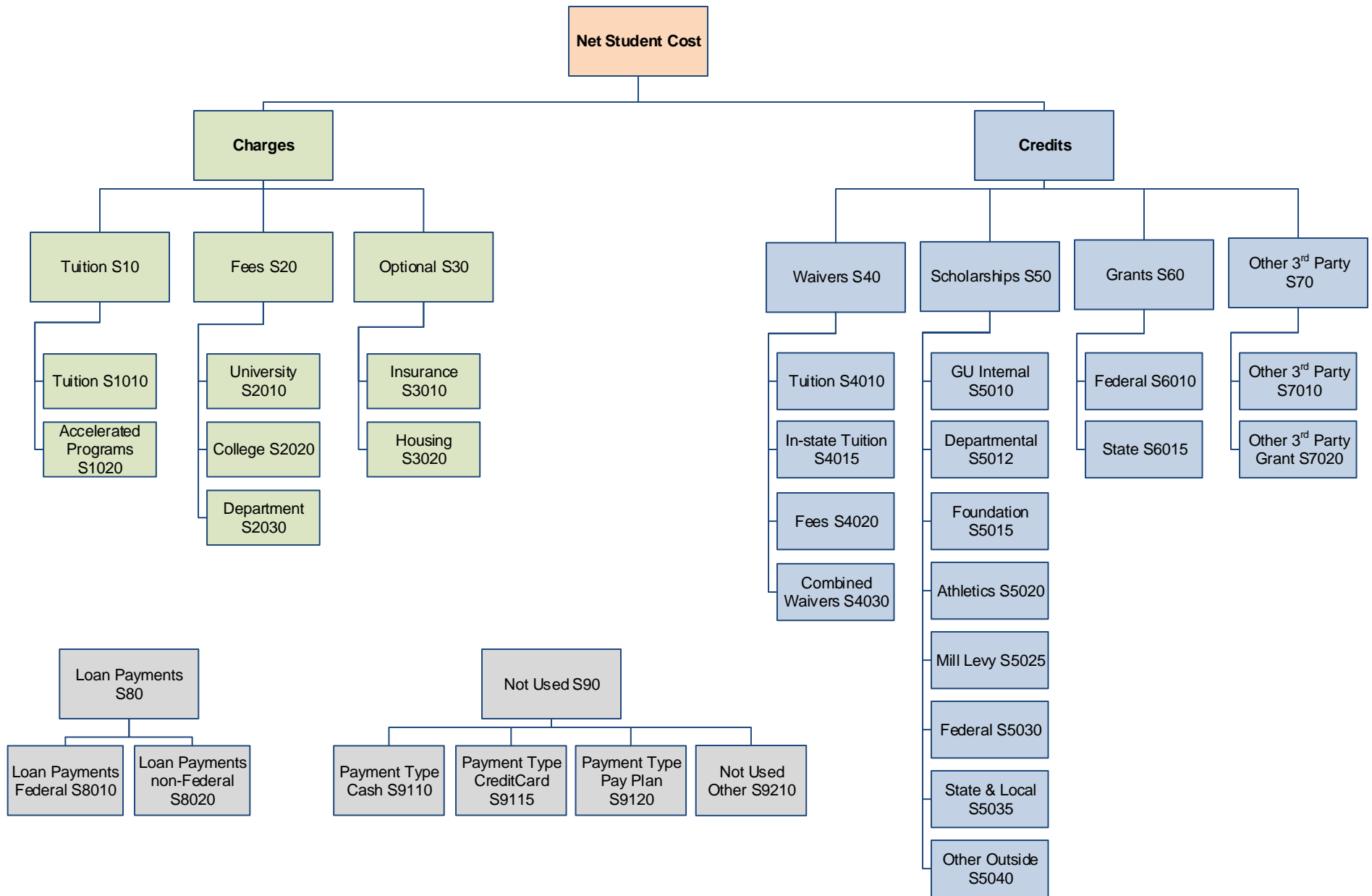

(Revised 09/02/2013)

# SV\_Term\_Codes [Validation] Term Codes and Descriptors

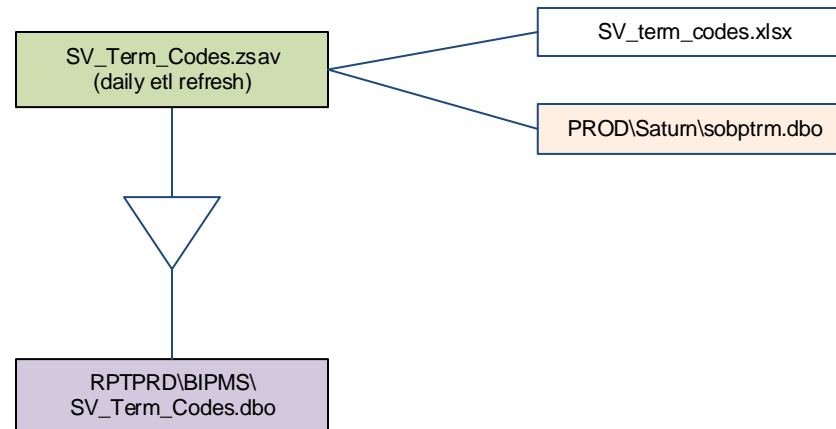

Notes: Daily ETL ran to pick up any term code additions.  
Provides data to BIPM builds, includes legacy and banner term codes and descriptors, 20<sup>th</sup> day dates, and semester date values.  
RPTPRD index on TERM.

Revised 02/04/2014.

# SV\_Time\_Codes [Validation] Time Codes

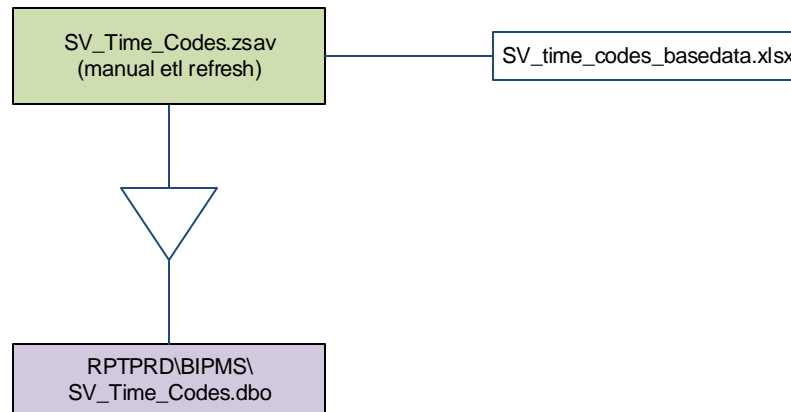

Provides time dimensions (hours, minutes, seconds) coding standards.

RPTPRD index on TIME24NUM.

Revised 01/14/2015.